

Mobile Arm for Disabled People Assistance – Manipulability Analysis

Khiair NAIT-CHABANE, Philippe HOPPENOT, Etienne COLLE
 LSC, University of Evry, France <http://lsc.univ-evry.fr>
 chabane | hoppenot | colle@iup.univ-evry.fr

Abstract

In this paper, we present the influence of the presence of a mobile platform on manipulability measure. We propose a normalized measure to solve problems inherent to physical units and velocity limits of the system. Simulation results on three dimensional positioning task are given to show the effect of nonholonomic constraint on manipulability measure. Manipulability is a well-established tool for motion analysis which will be used as criterion in control scheme to improve the coordination of two subsystems.

1. Introduction

The assistance with the seizure or the handling of usual objects by a handicapped person of the upper limbs aims at restoring some of the vital functions of the everyday life but also allows leisure or vocational activities. The principle consists in using a manipulator arm like a robotized assistant between the disabled person and her environment. Different arm configurations have been proposed. The first one consists in fixed working station in which a manipulator arm evolves in a structured environment (RAID-MASTER [1], PROVAR [2]). The second configuration consists in embarking a manipulator arm on an electrical wheelchair [3]. The third configuration permits to enlarge the action field of the system. A manipulator arm is embarked on a mobile base (MoVAR [4], URMAD-MOVAID [5], and ARPH [6]).

The key question of research on a robotized assistant is the utilisability by a person whose capacities of control are reduced. From our point of view, two research orientations must be investigated. The human-machine co-operation which we approached according to the concept of appropriation of Piaget [7], and mobile arm dexterity which is the subject of this paper.

The robotized assistant which consists of mobile manipulator arm is described section 2. Combining the mobility of the platform and the manipulator arm creates redundancy since the combined system typically possesses more degrees of freedom than

necessary. It is interesting to exploit the redundancy of the system in order to choose the best configuration of the arm “hand” for a grasping task. Section 3 introduces the well known concept of manipulability and its different measures. Relative influence of the two parts of the system (arm and mobile platform) is discussed in section 4. Simulations results illustrated in section 5 show the sensitivity of the manipulability when we consider the arm alone and the arm with platform.

2. Description and modeling of the robotized assistant

The mobile manipulator used in ARPH project [6] consist of a Manus arm manufactured by Exact Dynamics company [3], mounted on a mobile platform powered by two independent drive wheels.

Let us define a fixed world frame of reference $\{W\}$, a moving platform frame $\{P\}$ attached to the middle of the two drive wheels. A moving arm frame $\{A\}$ related to the manipulator base and a moving end-effector frame $\{E\}$ attached to the arm end-effector (Fig.1).

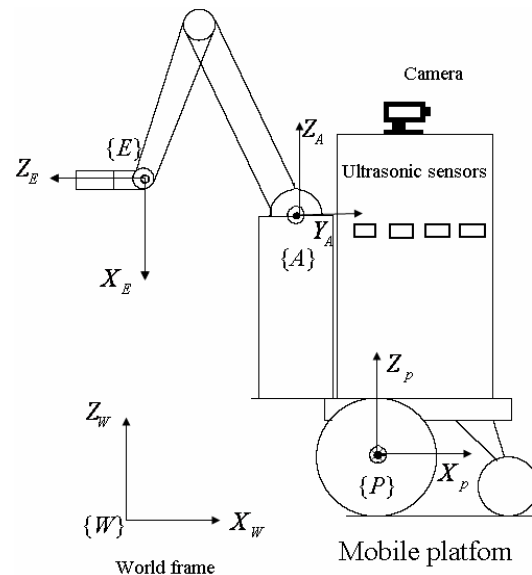

Figure 1. Mobile arm manipulator

In the following the indices (a, p) will respectively indicate the arm and the platform.

The forward kinematics of a serial chain manipulator that relates the joint space and the task space variables is expressed by

$$X_a = f_a(q_a) \quad (1)$$

where $X_a = [x_{a1}, x_{a2}, \dots, x_{am}]^T \in R^m$ is the vector of the task variables in m -dimensional task space, $q_a = [q_{a1}, q_{a2}, \dots, q_{an}]^T \in R^n$ is the vector of joint variables in the n -dimensional variables, called generalized coordinates and f_a is the nonlinear function of the forward kinematic mapping. Differentiating equation (1) with respect to time, we obtain a linear equation in velocity level

$$\dot{X}_a = J_a(q_a)\dot{q}_a \quad (2)$$

where \dot{X}_a is the task velocity vector, \dot{q}_a is the joint velocity vector, and $J_a(q_a)$ is Jacobian matrix.

For kinematic modeling of the considered manipulator arm, we use the Denavit Hartenberg parameters [8]. Manus arm has six rotoide joints, with 3DOF for gripper positioning and 3DOF for gripper orientation. In this paper, we consider only the main three joints of the arm given by the generalized vector $q_a = [q_{a1}, q_{a2}, q_{a3}]^T$.

The Cartesian coordinates of the end-effector relative to the arm base frame $\{A\}$ are given by

$$X_a = \begin{cases} x_{a1} = (L_4c_3 + L_3c_2)c_1 - L_2s_1 \\ x_{a2} = (L_4c_3 + L_3c_2)s_1 + L_2c_1 \\ x_{a3} = L_4s_3 + L_3s_2 \end{cases} \quad (3)$$

The derivative of the system (3) gives the following Jacobian matrix

$$J_a = \begin{bmatrix} -(L_4c_3 + L_3c_2)s_1 - L_2c_1 & -L_3c_1s_2 & -L_4c_1s_3 \\ (L_4c_3 + L_3c_2)c_1 - L_2s_1 & -L_3s_1s_2 & -L_4s_3s_1 \\ 0 & L_3c_2 & L_4c_3 \end{bmatrix} \quad (4)$$

where $c_i = \cos(q_{ai})$, $s_i = \sin(q_{ai})$ and L_2, L_3, L_4 represents respectively the length of shoulder, upper arm and lower arm.

The location of the platform is given by three operational coordinates x_p, y_p and θ_p defining its position and orientation as shown in figure 2.

Therefore, $q_p = [x_p, y_p, \theta_p]^T$ and a generalized velocities vector is $\dot{q}_p = [\dot{x}_p, \dot{y}_p, \dot{\theta}_p]^T$.

The constraint equation to which the platform is subjected has the following form

$$A(q_p)\dot{q}_p = 0 \quad (5)$$

where $A(q_p) = [\sin(\theta_p) \quad -\cos(\theta_p) \quad 0]$.

The configuration differential kinematic model of the mobile platform is given by ([9], [10])

$$\dot{q}_p = \begin{bmatrix} \cos(\theta_p) & 0 \\ \sin(\theta_p) & 0 \\ 0 & 1 \end{bmatrix} \begin{bmatrix} v \\ \omega \end{bmatrix} = S(q_p)u_p \quad (6)$$

where $u_p = [v, \omega]^T$ are respectively the linear and angular velocities of the platform.

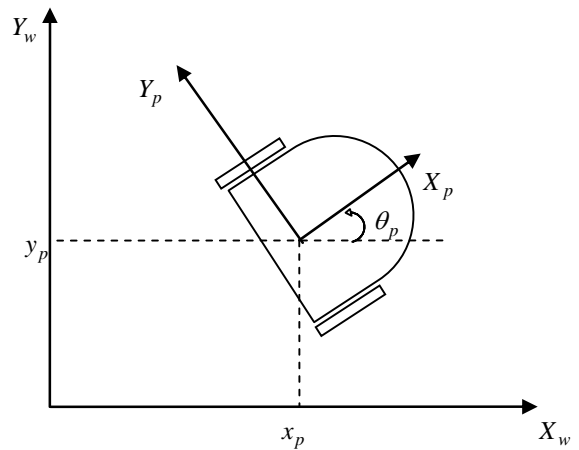

Figure 2. Wheeled mobile platform

The forward kinematic model of the mobile manipulator may be expressed as ([11],[12])

$$X = f(q_p, q_a) \quad (7)$$

where q_p is the generalized coordinates of the mobile platform and q_a joint variables of the arm.

Thus, the configuration of the mobile arm is defined by the N generalized coordinates ($N=6$ in our case)

$$q = [q_p^T, q_a^T]^T = [x_p, y_p, \theta_p, q_{a1}, q_{a2}, q_{a3}]^T$$

The direct kinematic model for the positioning task of the considering mobile arm relative to world frame $\{W\}$ is given by

$$X = [x_1, x_2, x_3]^T = f(q_a, q_p) \quad (8)$$

$$X = \begin{cases} x_1 = x_p + (x_{a2} + a)\cos(\theta_p) - (b - x_{a1})\sin(\theta_p) \\ x_2 = y_p + (x_{a2} + a)\sin(\theta_p) + (b - x_{a1})\cos(\theta_p) \\ x_3 = x_{a3} + c \end{cases}$$

where a , b and c are the Cartesian coordinates of the base arm with respect to the mobile platform frame $\{P\}$.

The instantaneous kinematic model is

$$\dot{X} = J(q)\dot{q} \quad (9)$$

with $J(q) = \frac{\partial f}{\partial q}$.

We notice that generalized velocities \dot{q} are dependent; they are linked by the nonholonomic constraint.

The platform constraint described by the equation (5) can be written in the following form

$$[A(q_p) \ 0]\dot{q} = 0 \quad (10)$$

According to equation (6), the relation between the generalized velocities vector of the system and its control velocities can be written as

$$\dot{q} = \begin{bmatrix} S_p(q_p) & 0 \\ 0 & I_n \end{bmatrix} u \quad (11)$$

where I_n is n -order identity matrix ($n=3$ in our case) and $u = [v, w, \dot{q}_{a1}, \dot{q}_{a2}, \dot{q}_{a3}]^T$.

The instantaneous kinematic model does not include the nonholonomic constraint of the platform given by the equation (10).

The relation between the operational velocities of the mobile manipulator and its control velocities, which takes into account the nonholonomic constraint of the platform can be expressed by the instantaneous kinematic model ([9], [11])

$$\dot{X} = \bar{J}(q)u \quad (12)$$

with $\bar{J}(q)$ is called reduced Jacobian.

For our system

$$\bar{J}(q) = \begin{bmatrix} c_{\theta_p} & \bar{J}_{12} & \bar{J}_{13} & \bar{J}_{14} & \bar{J}_{15} \\ s_{\theta_p} & \bar{J}_{22} & \bar{J}_{23} & \bar{J}_{24} & \bar{J}_{25} \\ 0 & 0 & J_{a31} & J_{a32} & J_{a33} \end{bmatrix} \quad (13)$$

where

$$c_{\theta_p} = \cos(\theta_p), \quad s_{\theta_p} = \sin(\theta_p) \\ J_{aij} = J_a(i, j) \text{ are given in equation (4)}$$

$$\bar{J}_{12} = -(x_{a2} + a)s_{\theta_p} - (b - x_{a1})c_{\theta_p}, \quad \bar{J}_{13} = J_{a21}c_{\theta_p} + J_{a11}s_{\theta_p} \\ \bar{J}_{14} = J_{a22}c_{\theta_p} + J_{a12}s_{\theta_p}, \quad \bar{J}_{15} = J_{a23}c_{\theta_p} + J_{a13}s_{\theta_p},$$

$$\bar{J}_{22} = (x_{a2} + a)c_{\theta_p} - (b - x_{a1})s_{\theta_p}, \quad \bar{J}_{23} = J_{a21}s_{\theta_p} - J_{a11}c_{\theta_p}, \\ \bar{J}_{24} = J_{a22}s_{\theta_p} - J_{a12}c_{\theta_p}, \quad \bar{J}_{25} = J_{a23}s_{\theta_p} - J_{a13}c_{\theta_p}.$$

3. Manipulability

One of the well-established tools for motion analysis of manipulator robot is the manipulability ellipsoid approach. Concept of the manipulability was originally introduced by Yoshikawa ([13], [14]) for manipulator arms to denote the measure for the ability of a manipulator to move in certain directions. The set of all end-effector velocities that are realizable by joint velocities such that the Euclidean norm of \dot{q}_a , $\|\dot{q}_a\| = (\dot{q}_{a1}^2 + \dot{q}_{a2}^2 + \dots + \dot{q}_{am}^2)^{1/2}$, satisfies $\|\dot{q}_a\| \leq 1$, is an ellipsoid in m -dimensional Euclidean space. This ellipsoid represents an ability of manipulation. It is called the manipulability ellipsoid.

One of the representative measures of manipulation derived for the manipulability ellipsoid is

$$w = \sqrt{\det(J_a J_a^T)} = \sigma_{a1} \cdot \sigma_{a2} \dots \sigma_{am} \quad (14)$$

where σ_{ai} 's are the singular values of J_a , $0 \leq i \leq m$.

In literature, several other measures for kinematic manipulability have been given ([15], [16], [13]). Manipulability has been utilized in many applications such as design, path planning and control of redundant manipulators ([17], [12], [16]). In the field of mobile manipulators, Yamamoto ([18]) has developed a control algorithm for mobile platform so that the manipulator arm is always positioned at the preferred configuration measured by its manipulability. A non linear feedback compensates the dynamic interaction between the mobile platform and the manipulator. Nagatani ([19]) has proposed an approach to plan mobile base's path which satisfies manipulator's manipulability. Controllers used for manipulation and locomotion are different.

Manipulability of mobile manipulator has been studied by few research groups. Yamamoto and Yun ([20]) have treated both locomotion and manipulation in the same framework from the viewpoint of task space. They present kinematic and dynamic contributions of manipulator and platform by the so called task space ellipsoid. Gardner and Velinsky ([21]) have used the mobile manipulator manipulability in design purpose. The authors introduce numeric

comparisons that allow to choose the position of a 3DOF anthropomorphic arm on the platform. Bayle et al. ([9], [10]) have extended the definition of manipulability to the nonholonomic mobile manipulators described by its reduced direct instantaneous kinematic model. Authors have defined a qualitative measure of manipulability extending the notion of ellipse eccentricity as

$$w_5 = \sqrt{1 - \frac{\sigma_m^2}{\sigma_1^2}} \quad (15)$$

σ_1 , σ_m being respectively maximum and minimum singular values of \bar{J} . The measure has been used as criterion to control mobile manipulator.

4. Respective influences of the different part of the system

Manipulator manipulability measure w has the advantage to be easy to compute. However, its numerical value does not constitute an absolute measure of closeness of the arm to singularities. Hence, it is convenient to consider the ratio between the minimum and maximum singular values of the Jacobian or to use w_5 which are not affected by the measure units.

In the case of mobile manipulator, the relation between the operational velocities \dot{X} of the end-effector and velocity vector of the system $u = [v, \omega, \dot{q}_{a1}, \dot{q}_{a2}, \dot{q}_{a3}]^T$ can be expressed by reduced direct instantaneous kinematic model vector of the system ([9]).

\dot{X} is expressed in m.s^{-1} . u is expressed in m.s^{-1} for the first linear velocity and in rad.s^{-1} for other ones. So coefficients of \bar{J} have different units: no unit for the first column and meter for the last four ones. This is an important difference with the case of the arm alone. Indeed, in this last case all coefficients of J_a have the same unit. To solve this problem and to include the constraint on the maximum velocities of the system into manipulability, we must introduce the following normalized velocities in deriving reduced Jacobian.

$$u_N = \left[\frac{v}{v_{\max}}, \frac{\omega}{\omega_{\max}}, \frac{\dot{q}_{a1}}{\dot{q}_{a1,\max}}, \frac{\dot{q}_{a2}}{\dot{q}_{a2,\max}}, \frac{\dot{q}_{a3}}{\dot{q}_{a3,\max}} \right]^T \quad (16)$$

Thus,

$$u_N = R^{-1}u \quad (17)$$

where

$$R = \text{diag}(v_{\max}, \omega_{\max}, \dot{q}_{a1,\max}, \dot{q}_{a2,\max}, \dot{q}_{a3,\max}) \quad (18)$$

Note that diag is diagonal matrix whose diagonal elements are specified by the arguments.

With these normalized control velocities, we can rearrange (12) as

$$\dot{X} = \bar{J}u = (\bar{J}R)u_N = \bar{J}_N u_N \quad (19)$$

$$\dot{X} = \bar{J}_N(q)u_N \quad (20)$$

With this new reduced Jacobian \bar{J}_N , we can define another manipulability measure as the following quantity

$$\tilde{w}_5 = \sqrt{1 - \frac{\tilde{\sigma}_m^2}{\tilde{\sigma}_1^2}} \quad (21)$$

$\tilde{\sigma}_1$, $\tilde{\sigma}_m$ being respectively maximum and minimum singular values of \bar{J}_N .

5. Simulation results

5.1. Arm alone

We consider a Manus arm for a positioning task (3DOF). We examine the evolution of manipulability for operational task which consists in following straight line along x_{a1} from retracted configuration (point $(0, 0.12, 0)^T \text{m}$) to extended one.

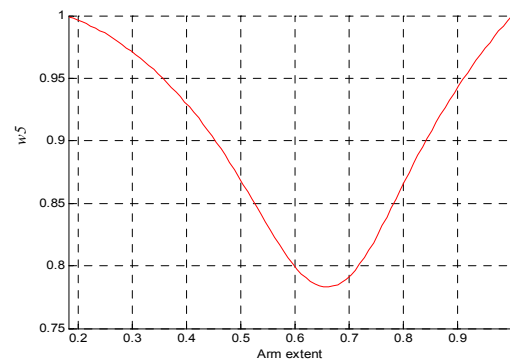

Figure 3. Arm Manus manipulability for positioning task

Figure 3 displays the evolution of the manipulability w_5 according to the normalized arm extension $x_{a1}/x_{a1,\max}$. The measure gives not only singular configurations ($w_5=1$) but also a direct measure of the ellipsoid eccentricity. When w_5 decreases to 0, the possible end-effector velocities are becoming more isotropic.

Figure 4 shows ellipses corresponding to largest and smallest singular values for certain configurations of the arm.

Ellipse shapes give information about the velocities distribution. Singular configurations correspond to a flat ellipse.

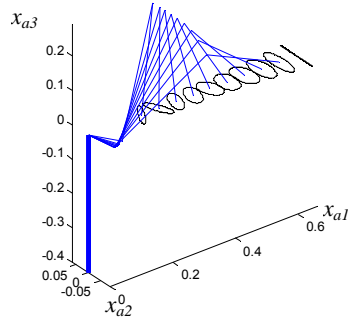

Figure 4. Manipulability ellipses

5.2. Mobile arm

We consider now Manus arm mounted on the mobile platform. We use same simulation conditions as in previous example. For this task, the platform does not move, but its capacity to move is taken into account in the computation of manipulability.

Figure 5 shows that mobile manipulator manipulability shape is the same as for the arm alone, and singular configurations remain the same. The mobile base cannot instantly move in direction perpendicular to its main axis because of the nonholonomic constraint. Therefore, the manipulability of the whole system is reduced to the one of the arm.

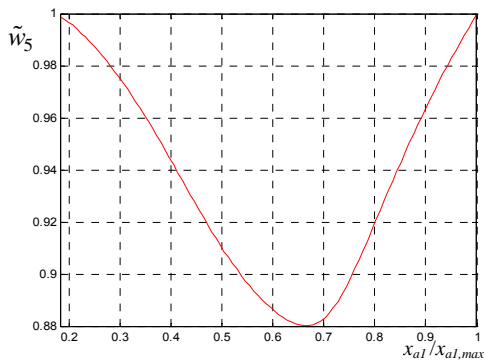

Figure 5. Manipulability of the mobile manipulator

Figure 6 shows the evolution of the manipulability of the mobile manipulator for the same task, but now the motion is along x_{a2} which corresponds to

longitudinal axis of the mobile base. The effects of the mobile base on the shape of ellipsoid and manipulability measure are relevant. The extended arm configuration becomes non singular. Thus, the platform contributes to the manipulability of the system.

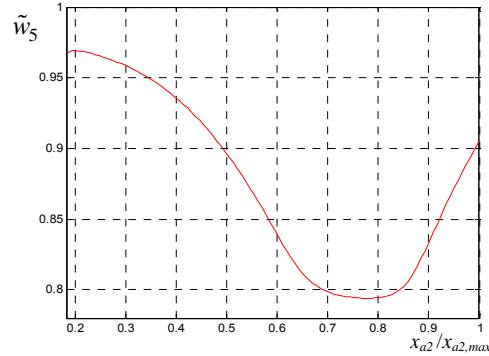

Figure 6. Manipulability of the mobile manipulator

5.3. Influence of arm and mobile platform on global manipulability measure

We still consider the example showing by figure 6 with the same 6DOF arm structure of different sizes. Figure 7 shows influence of arm link lengths on the manipulability of the whole system. If the arm is too small, its outstretched configuration will be not singular because the platform effect is dominant. A longer arm has more influence on the manipulability of the system.

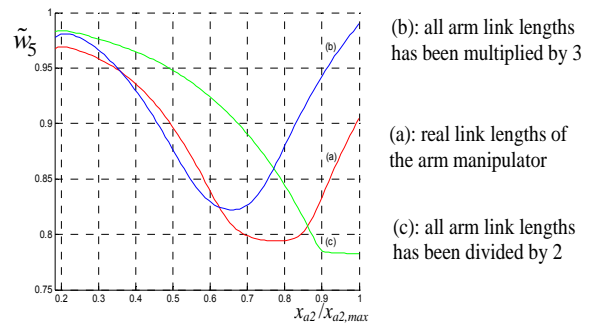

Figure 7. Influence of the arm and the platform on the mobile arm manipulability

6. Conclusion

In this paper, we have presented manipulability of arm and mobile manipulator systems for positioning task in three dimensional space. The main links of the arm are implied in the execution of this task. The choice of measure w_5 is interesting because it gives

qualitative information on the distribution of the velocities in the task space. We proposed to use \tilde{w}_5 which is normalized and takes into account maximum velocities of the system. This global and normalized measure conceals some possible directions of motion. The qualitative information is not sufficient to realize an efficient control of the mobile manipulator.

Current works are oriented into two directions. The first one is to include task information and reachability condition on the manipulability measure. The second one is to use these new measures as one of criteria for controlling redundant mobile manipulators.

7. References

- [1] J.P. Pedelucq et al., "Résultats des évaluations en centre spécialisé du système robotisé MASTER 1", 6^{ème} entretien de l'institut Garches, 1993.
- [2] K. Hagan Hillman MJS, Bien Z, "A wheelchair mounted assistive robot", ICORR'99, 1999.
- [3] <http://www.exactdynamics.nl/english/index.html>
- [4] H.F.M. Van der Loos, "VA/Stanford Rehabilitation Research and Development Program : Lessons Learned in the Application of Robotics Technology to the Field of Rehabilitation", IEEE Trans. Pn Rehabilitation Engineering, mars 1995, vol. 3, n°1, pp. 46-55.
- [5] P. Dario, E. Guglielmelli, B. Allotta, "MOVAID: a personal robot in everyday life of disabled and elderly people", Technology and Disability Journal, n°10, IOS Press, 1999, pp. 77-93.
- [6] P. Hoppenot, E. Colle, "Mobile robot command by man-machine co-operation - Application to disabled and elderly people assistance", Journal of Intelligent and Robotic Systems, July 2002, vol. 34, n°3, pp. 235-252.
- [7] J. Piaget, "The Origins of Intelligence in Children", N.Y.:The Norton Library, WW Norton & Co, Inc, 1952.
- [8] L. Sciavicco, B. Siciliano, "Modeling and control of robot manipulators", The McGraw-Hill companies, Inc. 1996.
- [9] B. Bayle, J.Y. Fourquet, M. Renaud, "Using manipulability with nonholonomic mobile manipulators", Int. Conf on Field and Service Robotics, Helsinki, Finland, June 2001, pp.343-348.
- [10] B. Bayle, J.Y. Fourquet, and M. Renaud, "Manipulability Analysis for Mobile Manipulators", In ICRA'2001, Séoul, South Korea, May 2001, pp. 1251-1256.
- [11] G. Foulon, J.Y. Fourquet, and M. Renaud. "Coordinating mobility and manipulation using nonholonomic mobile manipulators", In ISER'99, Sydney. Australia, March 1999, pages 115-125.
- [12] H. Seraji, "An on-line approach to coordinated mobility and manipulation", In ICRA'1993, Atlanta, Etats-Unis, mai 1993, pp. 28-35.
- [13] T. Yoshikawa, "Analysis and control of Robot manipulators with redundancy." In M. Brady & R. Paul, editeurs, Robotics Research : The First International Symposium, MIT Press, 1984, pages 735-747.
- [14] T. Yoshikawa, "Manipulability of Robotic Mechanisms", International Journal of Robotics Research, 1985, vol. 4, n° 2, pages 3-9.
- [15] J. LEE, "A study on the manipulability measures for robot manipulators", IROS1997.
- [16] T. Yoshikawa, "Foundation of robotics: Analysis and control", The MIT Press, 1990.
- [17] Y. Nakamura, "Advanced robotics, redundancy and optimization.", Addison Wesley Publishing, 1991.
- [18] Y. Yamamoto and X. Yun, "Coordinating locomotion and manipulation of mobile manipulator.", Recent Trends in Mobile Robots Zheng Y. Ed.1987.
- [19] K. Nagatani, T. Hirayama, A. Gofuku, Y. Tanaka, "motion planning for mobile Manipulator with keeping Manipulability", IROS 2002, Lausanne, Switzerland October 2002, pp 1663-1668.
- [20] Y. Yamamoto and X. Yun, "Unified analysis an mobility and manipulability of mobile manipulators", IEEE Int. Conf. Robotics and Automation, Detroit, USA, 1999, pp1200-1206.
- [21] J. Gardner, S Velinsky, "Kinematics of Mobile Manipulators and implications for Design", Journal of Robotic Systems, 2000, Vol.17, n°6, pages 309-320.

