Yasuhiro Fukuoka
Hiroshi Kimura

Graduate School of Information Systems
University of Electro-Communications
Chofu, Tokyo 182-8585, Japan
fukuoka@kimura.is.uec.ac.jp
hiroshi@kimura.is.uec.ac.jp

Avis H. Cohen

Department of Biology and Institute
for Systems Research
Univ. of Maryland
College Park, MD 20742, USA
ac61@umail.umd.edu

Adaptive Dynamic Walking of a Quadruped Robot on Irregular Terrain Based on Biological Concepts

Abstract

We have been trying to induce a quadruped robot to walk with medium walking speed on irregular terrain based on biological concepts. We propose the necessary conditions for stable dynamic walking on irregular terrain in general, and we design the mechanical system and the neural system by comparing biological concepts with those necessary conditions described in physical terms. A PD controller at the joints can construct the virtual spring-damper system as the visco-elasticity model of a muscle. The neural system model consists of a central pattern generator (CPG) and reflexes. A CPG receives sensory input and changes the period of its own active phase. The desired angle and P-gain of each joint in the virtual spring-damper system is switched based on the phase signal of the CPG. CPGs, the motion of the virtual spring-damper system of each leg and the rolling motion of the body are mutually entrained through the rolling motion feedback to CPGs, and can generate adaptive walking. We report on our experimental results of dynamic walking on terrains of medium degrees of irregularity in order to verify the effectiveness of the designed neuro-mechanical system. We point out the trade-off problem between the stability and the energy consumption in determining the cyclic period of walking on irregular terrain, and we show one example to solve this problem. MPEG footage of these experiments can be seen at <http://www.kimura.is.uec.ac.jp>.

KEY WORDS—AUTHOR: PLEASE PROVIDE

1. Introduction

Many previous studies of legged robots have been performed, including studies on running (Hodgins and Raibert 1991) and dynamic walking (Yamaguchi, Takanishi, and Kato 1994; Kajita and Tani 1996; Chew, Pratt, and Pratt 1999; Yoneda, Iiyama, and Hirose 1994; Buehler et al. 1998) on irregular terrain. However, studies of autonomous dynamic adaptation allowing a robot to cope with an infinite variety of terrain irregularities have been started only recently and by only a few research groups. One example is the recent achievement of high-speed mobility of a hexapod over irregular terrain, with appropriate mechanical compliance of the legs (Saranli, Buehler, and Koditschek 2001; Cham et al. 2001). The purpose of this study is to realize high-speed mobility on irregular terrain using a mammal-like quadruped robot, the dynamic walking of which is less stable than that of hexapod robots, by referring to the marvelous abilities of animals to autonomously adapt to their environment.

As many biological studies of motion control have progressed, it has become generally accepted that the walking of animals is mainly generated at the spinal cord by a combination of a central pattern generator (CPG) and reflexes receiving adjustment signals from a cerebrum, cerebellum and brain stem (Grillner 1981; Cohen and Boothe 1999). A great deal of the previous research on this attempted to generate walking using a neural system model, including studies on dynamic walking in simulation (Taga, Yamaguchi, and Shimizu 1991; Taga 1995; Miyakoshi et al. 1998; Ijspeert 2001), and real robots (Kimura, Akiyama, and Sakurama 1999; Ilg et al. 1999; Tsujita, Tsuchiya, and Onat 2001; Lewis et al. 2003). But autonomously adaptable dynamic walking on

irregular terrain was rarely realized in those earlier studies. In this paper we report on our progress in the past couple of years using a newly developed quadruped called “Tekken”, which contains a mechanism designed for three-dimensional (3D) space walking (pitch, roll and yaw planes) on irregular terrain.

In this paper we would like to emphasize three key concepts: (1) the necessary conditions for stable dynamic walking on irregular terrain and the neural system model contributing to satisfy those conditions described in Sections 2.4 and 2.5; (2) the entrainment between pitching motion of legs, rolling motion of the body and CPGs described in Section 3; (3) the coupled-dynamics-based motion generation for autonomous adaptation described in Section 6.1. These key concepts are common to both animals and machines in spite of the differences in their mechanisms, actuators, sensors and so on.

2. Adaptive Dynamic Walking based on Biological Concepts

Methods for legged locomotion control are classified into zero moment point (ZMP) based control and limit-cycle-based control (Table 1). ZMP is the extension of the center of gravity considering inertia force and so on. It was shown that ZMP-based control is effective for controlling posture and low-speed walking of a biped (Takanishi et al. 1990) and a quadruped (Yoneda, Iiyama, and Hirose 1994). However, ZMP-based control is not good for medium- or high-speed walking from the standpoint of energy consumption, since a body with a large mass needs to be accelerated and decelerated by actuators in every step cycle.

In contrast, motion generated by the limit-cycle-based control has superior energy efficiency. But there is an upper bound of the period of the walking cycle, in which stable dynamic walking can be realized (Kimura, Shimoyama, and Miura 1990). It should be noted that control by a neural system consisting of CPGs and reflexes is dominant for various kinds of adjustments in medium-speed walking of animals (Grillner 1981). Full and Koditschek (1999) also pointed out that, in high-speed running, kinetic energy is dominant, and self-stabilization by a mechanism with a spring and a damper is more important than adjustments by the neural system. Our study is aimed at medium-speed walking controlled by CPGs and reflexes (Table 1).

In this paper, we define a “reflex” as joint torque generation based on sensor information and a “response” as CPG phase modulation through sensory feedback to a CPG.

2.1. The Quadruped “Tekken”

We designed Tekken (Figure 1(a)) to solve the mechanical problems which occurred in our past study using a planar quadruped “Patrush” (Kimura, Fukuoka et al. 2001). The

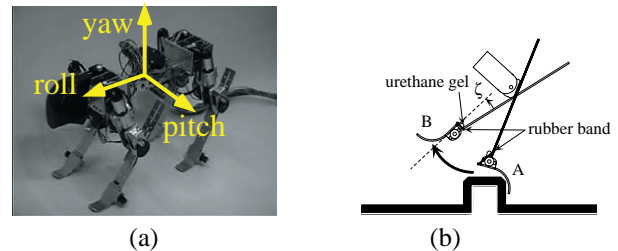

Fig. 1. A quadruped robot, Tekken: (a) photograph, (b) passive ankle joint.

lengths of the body and a leg in standing are 23 and 20 cm, respectively. The weights of the whole robot, a whole leg and a lower link under a knee are 3.1, 0.5 and 0.06 kg, respectively. Each leg has a hip pitch joint, a hip yaw joint, a knee pitch joint, and an ankle pitch joint. The hip pitch joint, knee pitch joint and hip yaw joint are activated by dc motors of 20, 20 and 5 W through gear ratios of 15.6, 18.8 and 84, respectively.

The ankle joint can be passively rotated in the direction shown by A in Figure 1(b) if the toe contacts with an obstacle in a swing phase, and is locked while the leg is in a stance phase. This passive mechanism quickly prevents a swinging leg from stumbling on an obstacle. In Figure 1(b), since the urethane gel inserted between two links is crushed elastically in a stance phase, we can detect the contact of a leg with the floor by the potentiometer at the ankle joint. As a result, we can detect three states of a leg by the ankle joint angle, ζ : stance ($\zeta < 3^\circ$), swinging in the air ($\zeta \simeq 10^\circ$) and stumbling on an obstacle ($\zeta > 20^\circ$).

Two rate gyro sensors and two inclinometers for pitch and roll axes are mounted on the body in order to measure the body pitch and roll angles. The direction in which Tekken moves while walking can be changed by using the hip yaw joints.

2.2. Rhythmic Motion by CPG

Although actual neurons as a CPG in higher animals have not yet become well known, features of a CPG have been actively studied in biology, physiology, and so on. Several mathematical models have also been proposed, and it has been pointed out that a CPG has the capability to generate and modulate walking patterns and to be mutually entrained with a rhythmic joint motion (Grillner 1981; Cohen and Boothe 1999; Taga, Yamaguchi, and Shimizu 1991; Taga 1995). As a model of a CPG, we used a neural oscillator (NO) proposed by Matsuoka (1987), and applied to the biped simulation by Taga, Yamaguchi, and Shimizu (1991) and Taga (1995). A single NO consists of two mutually inhibiting neurons (Figure 2). Each neuron in this model is represented by the following nonlinear differential equations:

Table 1. Biological Concepts of Legged Locomotion Control

	ZMP-based Control	Limit-cycle-based Control	
		by Neural System (CPG and Reflexes)	by Mechanism (Spring and Damper)
Good for control of	Posture and low-speed walking	Medium-speed walking	High-speed running
Main controller	Upper neural system acquired by learning	Lower neural system (at spinal cord, brain stem, etc.)	Musculoskeletal system through self stabilization

$$\begin{aligned}
 \tau \dot{u}_{\{e,f\}i} &= -u_{\{e,f\}i} + w_{fe} y_{\{f,e\}i} - \beta v_{\{e,f\}i} \\
 &\quad + u_0 + Feed_{\{e,f\}i} + \sum_{j=1}^n w_{ij} y_{\{e,f\}j} \\
 y_{\{e,f\}i} &= \max(u_{\{e,f\}i}, 0) \\
 \tau' \dot{v}_{\{e,f\}i} &= -v_{\{e,f\}i} + y_{\{e,f\}i}.
 \end{aligned} \tag{1}$$

Here the subscripts e , f , and i denote an extensor neuron, a flexor neuron, and the i th NO, respectively. $u_{\{e,f\}i}$ is u_{ei} or u_{fi} , that is, the inner state of an extensor neuron or a flexor neuron of the i th NO; $v_{\{e,f\}i}$ is a variable representing the degree of the self-inhibition effect of the neuron; y_{ei} and y_{fi} are the outputs of extensor and flexor neurons; u_0 is an external input with a constant rate; $Feed_{\{e,f\}i}$ is a feedback signal from the robot, that is, a joint angle, angular velocity and so on; and β is a constant representing the degree of the self-inhibition influence on the inner state. The quantities τ and τ' are time constants of $u_{\{e,f\}i}$ and $v_{\{e,f\}i}$; w_{fe} is a connecting weight between flexor and extensor neurons; w_{ij} is a connecting weight between neurons of the i th and j th NO.

In Figure 2, the output of a CPG is a phase signal, y_i :

$$y_i = -y_{ei} + y_{fi}. \tag{2}$$

The positive or negative value of y_i corresponds to the activity of a flexor or extensor neuron, respectively. We use the following hip joint angle feedback as a basic sensory input to a CPG called a ‘‘tonic stretch response’’ in all experiments of this study. This negative feedback makes a CPG entrained with a rhythmic hip joint motion.

$$Feed_{e-tsr} = k_{tsr}(\theta - \theta_0), \quad Feed_{f-tsr} = -Feed_{e-tsr} \tag{3}$$

$$Feed_{\{e,f\}} = Feed_{\{e,f\}-tsr} \tag{4}$$

where θ is the measured hip joint angle, θ_0 is the origin of the hip joint angle in standing and k_{tsr} is the feedback gain. We eliminate the subscript i when we consider a single NO.

By connecting the CPG of each leg (Figures 3(a) and (b)), CPGs are mutually entrained and oscillate in the same period

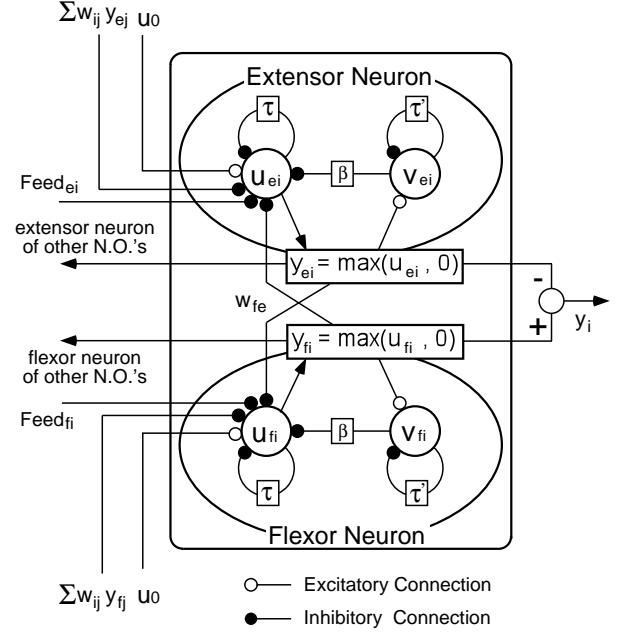
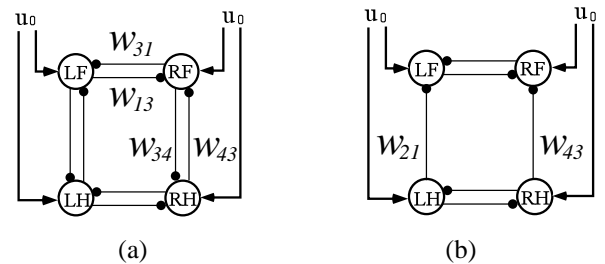

Fig. 2. Neural oscillator as a model of a CPG.

 Fig. 3. CPG network for (a) Patrush and (b) Tekken. The subscripts $i, j = 1, 2, 3, 4$ correspond to LF, LH, RF, RH. L, R, F and H denote the left, right, fore or hind legs, respectively.

and with a fixed phase difference. This mutual entrainment between the CPGs of the legs results in a gait. The gait is a walking pattern, and can be defined by phase differences ($0 \sim 1$) between the legs during their pitching motion. When we use γ for the phase difference from the left hind leg to the left fore leg, the typical symmetric gaits are a trot ($\gamma \simeq 0.5$) and a pace ($\gamma \simeq 0$). Diagonal legs and lateral legs are paired and move together in a trot gait and a pace gait, respectively. A walk gait is the transversal gait between the trot and pace gaits (Table 2).

Since there is not much meaning in a gait of planar walking, the gait of Patrush was fixed to a trot gait using the symmetric CPG network (Figure 3(a)). However, since a gait is one of the important subjects in 3D walking using Tekken, we newly propose an asymmetric CPG network shown in Figure 3(b) in order to generate an arbitrary gait from a trot to a pace via a walk with a single network configuration of CPGs. In Figure 3(b), a CPG of a fore leg is inhibited by a CPG of a hind leg with a connecting weight, $w_{\{21,43\}}$, and a CPG of a hind leg is not inhibited by a CPG of a fore leg ($w_{\{12,34\}}=0$).

2.3. Virtual Spring–Damper System

Muscles and tendons of animals act as a spring–damper system in medium- and high-speed walking and running, and play an important role for stabilization and energy storage. The whole visco-elasticity of a muscle is the sum of its own visco-elasticity as a material and the visco-elasticity as a result of feedback by the stretch reflex and others. It is also known that the muscle stiffness in the stretch reflex is almost proportional to the muscle tension, high in a stance phase for supporting a body against gravity and low in a swing phase for compliance against the disturbance, during the walking of cats (Akazawa et al. 1982). Full and Koditschek (1999) and Full (2000) pointed out the importance of the mechanical visco-elasticity of muscles and tendons independent of sensory input under the concepts of the “Spring Loaded Inverted Pendulum” (“SLIP”) and the “preflex”. These biological concepts were applied for the development of hexapods with high-speed mobility over irregular terrain (Saranli, Buehler, and Koditschek 2001; Cham et al. 2001). Although we refer to the concept of SLIP, we employ the model of the muscle stiffness, which is generated by the stretch reflex and variable according to the stance/swing phases, aiming at medium-speed walking on irregular terrain adjusted by the neural system.

All joints of Tekken are PD controlled to move to their

Table 2. Definition of Gaits

γ		Gait
$-0.025 \leq$	< 0.125	Pace
$0.125 \leq$	< 0.375	Walk
$0.375 \leq$	< 0.525	Trot

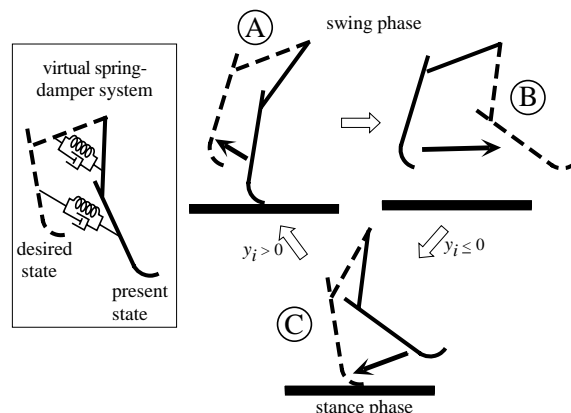

Fig. 4. State transition in the virtual spring–damper system. The desired joint angles in each state are shown by the dashed lines.

desired angles in each of three states (A, B, C) in Figure 4 in order to generate each motion such as swinging up (A), swinging forward (B) and pulling down/back of a supporting leg (C). The timing for all joints of a leg to switch to the next state are:

- A \rightarrow B when the hip joint angle of the leg reaches the desired angle of the state (A);
- B \rightarrow C when the CPG extensor neuron of the leg becomes active ($y_i \leq 0$);
- C \rightarrow A when the CPG flexor neuron of the leg becomes active ($y_i > 0$).

The desired angles and P-gain of each joint in each state are shown in Table 3, where constant values of the desired joint angles and constant P-gains were determined through experiments. The values of P-gain, $G_{1\sim 8}$, are shown in Table 4, where the stiffness in a stance phase, G_5, G_7 , is larger than the stiffness in a swing phase, G_3, G_6 , similar to that observed in cats. The desired angular velocity and D-gain of all joints in all states are fixed to 0 rad s^{-1} and $0.03 \text{ Nm s rad}^{-1}$, respectively.

Since Tekken has high backdrivability with small gear ratio in each joint, the PD controller can construct the virtual spring–damper system with relatively low stiffness coupled with the mechanical system. Such compliant joints of legs can improve the passive adaptability on irregular terrain.

2.4. Necessary Conditions for Stable Dynamic Walking on Irregular Terrain

The diagram of the pitching motion control consisting of CPGs and the virtual spring–damper system is shown in the middle part of Figure 5. Joint torque of all joints is determined

Table 3. Desired Value of the Joint Angles and P-gains at the Joints in Each State Used in the PD Controller for the Virtual Spring–damper System

Angle in State	P Control	
	Desired Value (rad)	P-gain (Nm rad ⁻¹)
θ in A	$1.2\theta_{C \rightarrow A}$	G_1
θ in B	-0.17	$G_2\nu + G_3$
θ in C	$\theta_{stance} +$ (body pitch angle)	$-G_4\nu + G_5$
ϕ in A & B	*	G_6
ϕ in C	0.61	G_7
ψ in all states	0	G_8

θ , ϕ , and ψ are the hip pitch joint angle, the knee pitch joint angle, and the hip yaw joint angle shown in Figure 5, respectively. The values of P-gain are updated at the beginning of each state. $\theta_{C \rightarrow A}$: the hip joint angle measured at the instance when the state changes from (C) to (A). θ_{stance} : variable to change the walking speed. body pitch angle: the pitching angle of the body measured at the every sampling time. * means that the desired angle is calculated at every sampling time for height from the toe to the hip joint to be the constant using the measured value of θ . ν (m s⁻¹): the walking speed of Tekken calculated using the measured joint angles of supporting legs at the every sampling time.

Table 4. Values of the Parameters Used in Experiments

Parameter	Value	Parameter	Value
u_0	1.0	θ_0 (rad)	-0.87
τ'	0.6	G_1 (Nm rad ⁻¹)	7.0
β	3.0	G_2 (Nm s rad ⁻¹)	0.5
w_{fe}	-2.0	G_3 (Nm rad ⁻¹)	0.4
$w_{\{13,31,24,42\}}$	-2.0	G_4 (Nm s rad ⁻¹)	1.4
$w_{\{12,34\}}$	0	G_5 (Nm rad ⁻¹)	2.0
$w_{\{21,43\}}$	-0.57	G_6 (Nm rad ⁻¹)	1.0
k_{lrr} (rad ⁻¹)	3.0	G_7 (Nm rad ⁻¹)	2.6
k_{tlrr} (rad ⁻¹)	3.3	G_8 (Nm rad ⁻¹)	1.0

by the PD controller, corresponding to a stretch reflex at an α motor neuron in animals. The desired angle and P-gain of each joint is switched based on the phase of the CPG output, y_i , in eq. (2) as described in Section 2.3. As a result of the switching of the virtual spring–damper system and the joint angle feedback signal to the CPG in eq. (4), the CPG and the pitching motion of the leg are mutually entrained.

With a constant connecting weight, $w_{\{13,31,24,42\}} = -2$, and various connecting weights, $w_{\{21,43\}}$ from -1 to 0.1 , we were able to realize dynamic walking on a flat terrain in various gaits, from a trot to a pace via a walk (Figure 6(a)). We were also able to make Tekken walk over terrain of low irregularity. But it was not smooth walking. We definitely have to employ the reflective mechanism based on sensory input for adaptive walking on terrain of medium and high degree of irregularity.

We propose the necessary conditions for stable dynamic walking on irregular terrain, which can be itemized in physical terms:

- the swinging legs should be free to move forward during the first period of the swing phase;
- the swinging legs should land reliably on the ground during the second period of the swing phase;
- the angular velocity of the supporting legs relative to the ground should be kept constant during their pitching motion around the contact points at the moment of landing or leaving;
- the phase difference between the rolling motion of the body and the pitching motion of the legs should be maintained regardless of a disturbance from irregular terrain;
- the phase differences between the legs should be maintained regardless of delay in the pitching motion of a leg receiving a disturbance from irregular terrain.

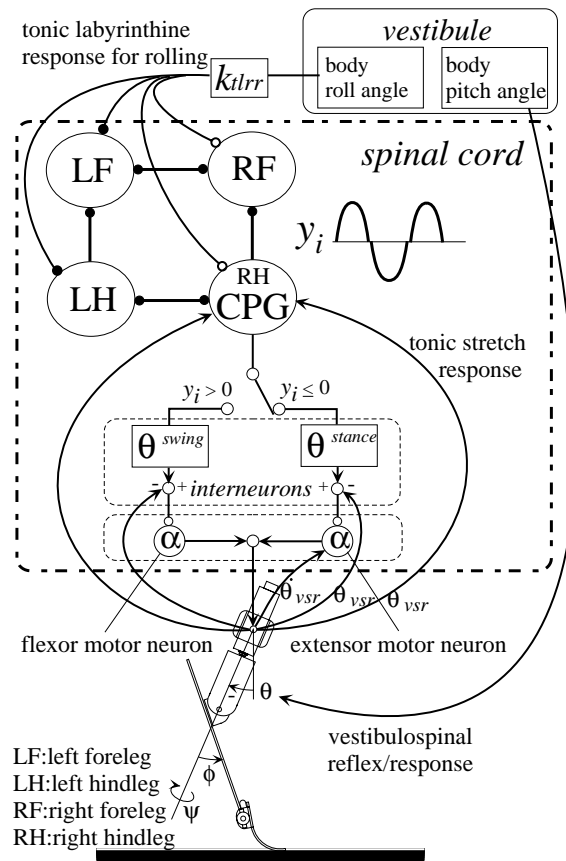

Fig. 5. Control diagram for Tekken. PD control at the hip yaw and knee pitch joints are eliminated in this figure.

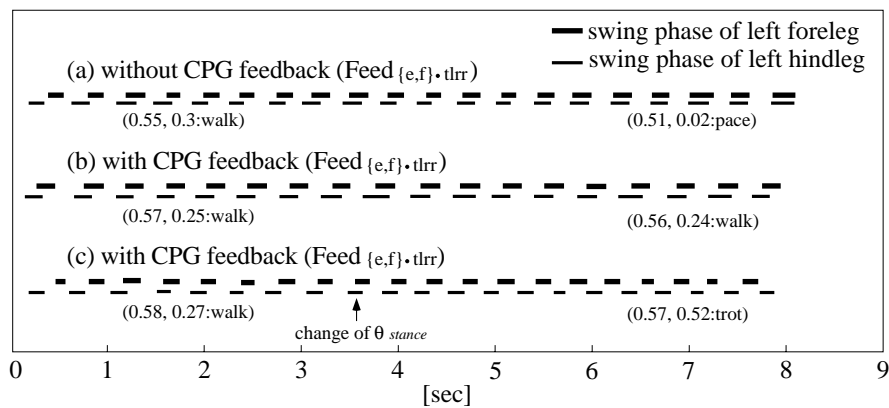

Fig. 6. Gaits obtained in walking experiments ($\tau = 0.04$, $\theta_{stance} = -0.7$). The swing phases of the right legs are shown by solid lines. $w_{[21,43]}$ is -0.4 , -0.4 and -0.7 in (a), (b) and (c), respectively. (Duty factor, γ : gait) at 2 and 7 s are shown.

2.5. Reflexes and Responses

It is well known in physiology that

- some sensory stimuli modify CPG activity and reflexive responses to sensory stimuli are phase-dependent under CPG activity (Cohen and Boothe 1999).

Such interaction between CPG activity and a sensory stimulus is very important for adaptation and corresponds to the necessary conditions described in physical terms in Section 2.4.

For example, the reflex to a stimulus on the paw dorsum in the walking of a cat depends on whether flexor or extensor muscles are active (Cohen and Boothe 1999). That is,

- when flexor muscles are active, the leg is flexed in order to escape from the stimulus;
- when extensor muscles are active, the leg is strongly extended in order to prevent the cat from falling down.

We call these the “flexor reflex” and the “extensor reflex”, respectively, and we assume that the phase signal from the CPG of the leg switches such reflexes. The flexor and extensor reflexes contribute to satisfy the conditions (a) and (b), respectively. In *Patrush*, the stumbling of a swinging leg on an obstacle was detected by the force sensor, and the flexor or extensor reflex was activated afterwards. However, the problem was that the robot easily fell down due to the delayed flexing motion caused by the delay of sensing and large inertia of the leg while walking with a short cyclic period. Therefore, we substitute the flexor reflex for the passive ankle joint mechanism described in Section 2.1 utilizing the fact that the collision with a forward obstacle occurs in the first half of a swing phase. The extensor reflex has not yet been implemented in *Tekken*.

In addition, the following biological concepts are known (Ogawa et al. 1998):

- when the vestibule in a head detects an inclination in pitch or roll plane, a downward-inclined leg is extended while an upward-inclined leg is flexed (Figure 7).

We call the reflex/response for an inclination in the pitch plane a “vestibulospinal reflex/response”, the role of which corresponds to conditions (c) and (e). In *Tekken*, the hip joint torque in the stance phase is adjusted by the vestibulospinal reflex, since the body pitch angle is added to θ_{stance} in Table 3. For the vestibulospinal response, the following equations are used rather than eqs. 3 and 4:

$$\begin{aligned} \theta_{vsr} &= \theta - (\text{body pitch angle}) \\ Feed_{\{e,f\}\text{-}tsr\text{-}vsr} &= \pm k_{tsr}(\theta_{vsr} - \theta_0). \end{aligned} \quad (5)$$

$$Feed_{\{e,f\}} = Feed_{\{e,f\}\text{-}tsr\text{-}vsr}. \quad (6)$$

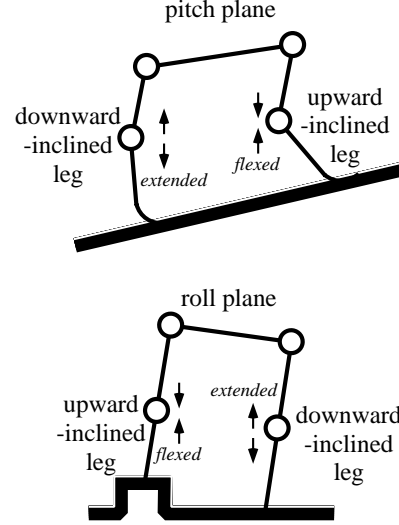

Fig. 7. Downward-inclined and upward-inclined legs.

On the other hand, we call the response for an inclination in the roll plane a “tonic labyrinthine response¹ for rolling”, the role of which corresponds to conditions (b) and (d). The tonic labyrinthine response for rolling is employed as rolling motion feedback to CPGs in Section 3.

In Table 3, P-gain of hip joints in states (B) and (C) is adjusted using the measured walking speed, v . For example, when v is increased in state (B) as the swing phase, the swinging legs land further forward because P-gain is increased and the swinging legs are more strongly pulled forward. As a result, the increase of v is depressed since the forward motion of the inverted pendulum in the next stance phase is depressed (Miura and Shimoyama 1994). On the other hand, when v is decreased in state (C) as the stance phase while walking up a slope, the increase of P-gain generates additional torque against the gravity load at hip joints of the supporting legs. As a result, the decrease of v is depressed. These reflexes are not named, but contribute to satisfying condition (c).

The necessary condition (e) can be satisfied by the mutual entrainments between CPGs and the pitching motion of legs, and the mutual entrainments among CPGs (Kimura, Fukuoka et al. 2001).

3. Entrainment Between Pitching and Rolling Motions

3.1. Rolling Motion Feedback to CPGs

Since *Tekken* has no joint around the roll axis, CPG-based joint control cannot be applied to the rolling motion.

1. The “tonic labyrinthine reflex” is defined in Ogawa et al. (1998). The same reflex is called “vestibular reflex” in Ghez (1991).

However, since a dynamic system similar to an inverted pendulum appears in the two-legged stance phase, a rolling motion is naturally generated in most of the gaits as a result. The amplitude of the rolling motion generated by walking on flat terrain is determined mainly by the gait, duty factor, and the period of the pitching motion cycle. As described by condition (d) in Section 2.4, the change of the phase difference between the rolling motion of the body and the pitching motion of legs disturbs stable walking. Since the feedback to CPGs described in Section 2 does not include the sensory signal from rolling motion, it is difficult to fix the phase difference between these two motions.

Therefore, we input the body angle around the roll axis to the CPGs as a feedback signal expressed by eq. (7) in order to synchronize rolling motion and pitching motion (upper-left part of Figure 5).

$$\begin{aligned} Feed_{e-tilrr} &= \delta(\text{leg}) k_{tilrr} \times (\text{body roll angle}) \\ Feed_{f-tilrr} &= -Feed_{e-tilrr} \end{aligned} \quad (7)$$

$$\delta(\text{leg}) = \begin{cases} 1, & \text{if leg is a right leg;} \\ -1, & \text{otherwise} \end{cases}$$

$$\begin{aligned} Feed_e &= Feed_{e-tilsr-usr} + Feed_{e-tilrr} \\ Feed_f &= Feed_{f-tilsr-usr} + Feed_{f-tilrr}. \end{aligned} \quad (8)$$

3.2. Rolling Motion as the Standard for Whole Oscillations

In Figure 8, CPGs, the pitching motion of the legs and the rolling motion of the body are mutually entrained through the rolling motion feedback to CPGs expressed by eq. (7). This means that the rolling motion can be the standard oscillation for whole oscillations, in order to compensate for the weak connection between the fore and hind legs in the CPG network (Figure 3(b)). As a result, the phase difference between the fore and hind legs is fixed, and the gait becomes stable.

We made Tekken walk with $w_{[21,43]} = -0.4$ and eq. (6). In Figure 6(a), the phase differences between the fore and hind legs were not fixed, and the actual gait gradually shifted to a pace gait due to differences of the stance period between the fore and hind legs, caused by an unbalanced gravity load between the legs. Although this means that phase differences between the legs were autonomously adjusted on the CPG network for condition (e) in Section 2.4 to be satisfied, such gait transition in a constant walking speed is not desirable.

We made Tekken walk with $w_{[21,43]} = -0.4$ and eq. (8). In Figure 6(b), walking with a walk gait was realized by keeping the phase difference between the fore and hind legs, with γ almost constant.

3.3. Tonic Labyrinthine Response for Rolling

When a leg lands on a bump while walking on irregular terrain, the disturbance of the rolling motion to the pitching motion becomes larger. Therefore, the periods of the current phases of

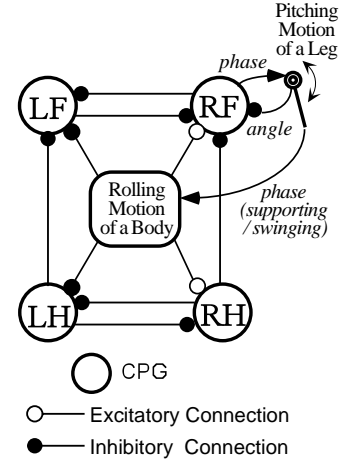

Fig. 8. Relationship between the CPGs, the pitching motion of a leg, and the rolling motion of the body when walking with rolling motion feedback to CPGs.

the CPGs in the pitching motion should be adjusted according to the rolling motion, in order to satisfy conditions (b) and (d) described in Section 2.4.

The rolling motion feedback to CPGs (eq. (7)) contributes to an appropriate adjustment of the periods of the stance and swing phases while walking on irregular terrain (Figure 9), as a tonic labyrinthine response for rolling (TLRR) described in Section 2.5. In Figure 9, the right fore leg lands on a bump in a trot gait, and the body is inclined in a roll plane. Extending the stance phase of the left hind leg (E+), and shortening the stance phase of the right fore leg (E-) and the swing phase of the left fore leg (F-) prevent the body from the excess inclination in a roll plane and help to satisfy condition (d). Extending the swing phase of the right hind leg (F+) enables the reliable landing of the leg on the ground and helps satisfy condition (b).

3.4. Stability Evaluation

In this study, we define the “wide stability margin” (WSM) as the shortest distance from the projected point of the center of gravity to the edges of the polygon constructed by the projected points of legs independent of their stance or swing phases (Figure 10). Since the WSM is used not for motion planning but for motion evaluation, not ZMP but the projected point of the center of gravity is used eliminating inertia force and so on for simplicity. In a robot such as Tekken, which can move a swinging leg quickly enough within the short cyclic period of walking (0.2–0.6), a swinging leg can land on the floor immediately if necessary in Figure 10. Therefore, the WSM can be the substitution of the conventional stability margin or the ZMP margin used in order to avoid excess

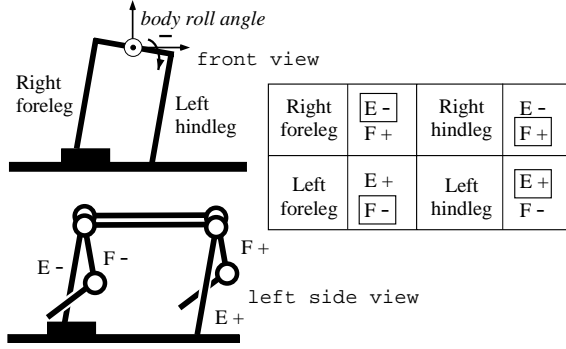

Fig. 9. A tonic labyrinthine response for rolling. E and F denote the extensor and flexor neuron of a CPG, respectively. “+” and “-” mean that the activity of the neuron is increased or decreased by $Feed_{(e,f),t_{lrr}}$, respectively.

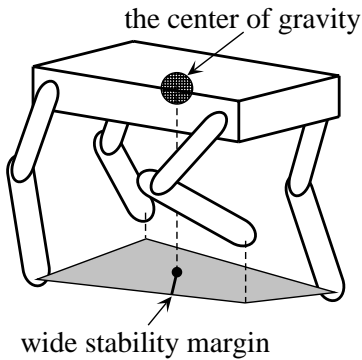

Fig. 10. The definition of the WSM.

angular acceleration around the line connecting two supporting points.

In Figure 11, WSM normalized by the body width of Tekken ($w = 120$ mm) is shown for various τ , the time constant of a CPG in eq. (1), and various $k_{t_{lrr}}$, gains of the rolling motion feedback to CPGs. The cyclic periods of walking corresponding to each value of τ are also shown in Figure 11. In Figure 11, high WSM was obtained without rolling motion feedback to CPG ($k_{t_{lrr}} = 0$) when walking with the short cyclic period ($T < 0.3$ s). This is because it is not necessary to entrain pitching motion with rolling motion, of which the amplitude becomes very small when walking with the short cyclic period. On the other hand, the amplitude of rolling motion when walking with the medium and large cyclic period ($T > 0.3$ s) becomes large, since the angular momentum around the line connecting two supporting points largely changes in the two-legged stance phase. In such cases, $k_{t_{lrr}}$ ($= 0$) makes walking not smooth or unstable due to the lack of

entrainment between rolling motion and pitching motion. We use $k_{t_{lrr}} (= 3.3)$, which gives $WSM > 0.3w$ for $T < 0.6$ s, as the optimal value for Tekken in all the following experiments.

4. Performance of Walking on Flat Terrain

4.1. Variables and Constants

θ_{stance} , τ and $w_{21} (= w_{43})$ are variables to change the indices of walking such as the walking speed, the cyclic period of walking and the gait, respectively. For examples, when we shorten the cyclic period of walking by decreasing τ , the stride becomes short since the period of state (B) in Figure 4 becomes short. As a result, the walking speed is kept almost constant. However, we cannot change the single index independent of other indices in general, since those variables influence all indices and walking is generated through interaction with floor.

Values of all parameters in the neural system including the virtual spring-damper system except for θ_{stance} and τ were determined experimentally. But it should be noted that those values were constant in the following experiments independent of terrain. Those values used in experiments are shown in Tables 3 and 4.

4.2. Walking Speed and Gait Transition

The walking speed, the cyclic period of walking and the gait are closely coupled in Tekken as described in Section 4.1. When $|\theta_{stance}|$ is increased, the supporting leg is pulled backward more strongly and quickly in state (C) of Figure 4, and the active period of the CPG extensor neuron is shortened by the hip joint motion feedback to the CPG (eq. (3)). As a result, the cyclic period of walking and duty factor is reduced, since the stance period is reduced and the swing period remains constant while the relative stride to the body is constant. Therefore, we can increase the walking speed and decrease the cyclic period of walking at once while τ is constant (Figure 12).

While the amplitude of the rolling motion is large, the gait is slightly shifted from the original gait to a pace, since eq. (7) has the same influence on the CPGs of the fore and hind legs in a lateral pair. When the walking speed is increased, the amplitude of the rolling motion is reduced (Figure 12), being proportional to the square of the cyclic period of walking (Kimura, Shimoyama and Miura 1990). As a result, the gait returns to the original gait, since the influence of the rolling motion in eq. (7) is reduced.

The results of the experiments are shown in Figures 6(c) and 13. When θ_{stance} was changed at 3.5 s, Tekken increased its walking speed from 0.3 to 0.5 m s⁻¹ in Figure 13, and the gait was autonomously transited from a walk to a trot in Figure 6(c). We can see that the cyclic period of walking was decreased from 0.64 to 0.48 s while τ is constant, and the amplitude of the rolling motion became much smaller after 3.5 s in Figure 13.

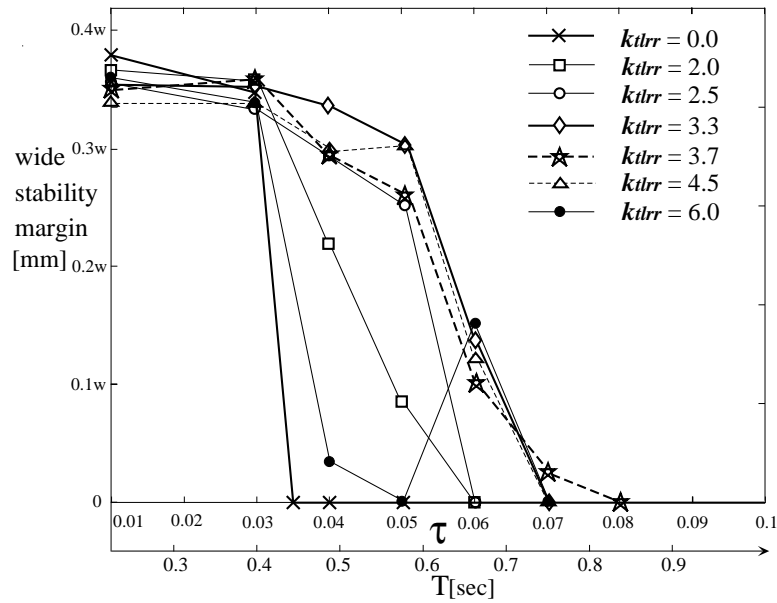

Fig. 11. WSM measured in experiments ($\theta_{stance} = -0.8$), which were carried out on a flat floor with various time constants of CPGs (τ) and various gains of the rolling motion feedback to CPGs (k_{trr}). All plotted points denote the average of the minimum WSM in three times experiments. The walking speed and distance were 0.5 m s^{-1} and 2 m in all experiments, respectively. The cyclic periods of walking (T) corresponding to τ are shown.

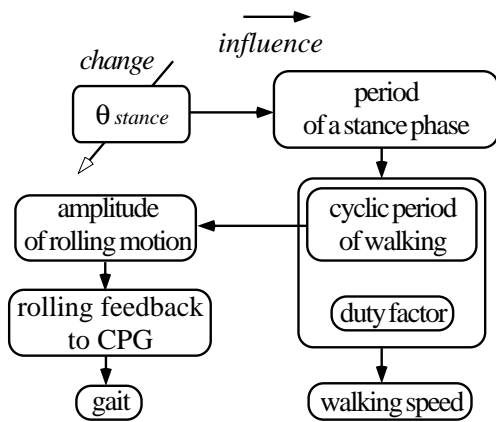

Fig. 12. Determination of the walking speed and the gait in changing θ_{stance} of Table 3.

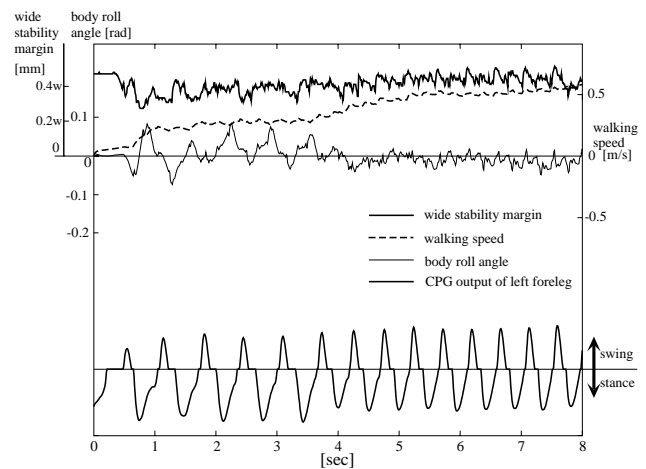

Fig. 13. The result of the experiment of changing walking speed with constant $\tau (= 0.04)$ and $w_{\{21,43\}} (= -0.57)$. θ_{stance} was changed from -0.7 to -0.8 rad at $t = 3.5$ s. We can see especially in the first half that CPG output and rolling motion of the body were mutually entrained.

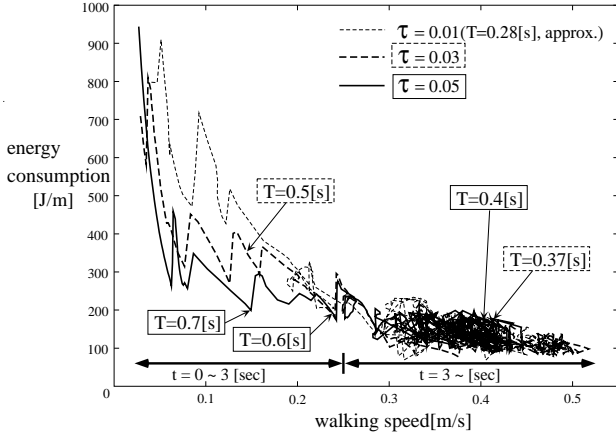

Fig. 14. The relation between the walking speed and the energy consumption when walking with three different values of τ . θ_{stance} was changed at 3 s in the same way as in Figure 13. The cyclic periods of walking (T) at several instants are also shown for each value of τ .

4.3. Energy Consumption Evaluation

The energy consumption with Joule thermal loss at dc motors calculated using the measured current value are shown in Figure 14 as the results of experiments with various values of τ .

In Figure 14, we can see that walking with a large value of τ , i.e., walking with the long cyclic period, is superior in the energy consumption while the walking speed is low ($0.05\text{--}0.2\text{ m s}^{-1}$). On the other hand, walking with a small value of τ is superior in the stability as shown in Figure 11. As a result, we have to solve the trade-off problem between the stability and the energy consumption in order to determine the value of τ under the given walk speed. In the following experiments, we use $\tau = 0.04$ taking the degree of irregularity of terrains into account if not specified.

5. Adaptive Walking on Irregular Terrain

Since the phase difference between the rolling motion of the body and the pitching motion of the legs can be largely disturbed when walking on irregular terrain, a TLRR is essential.

5.1. Experiments without TLRR

The results of experiments, where Tekken walked over an obstacle 2 cm in height and 4 cm in depth without a TLRR ($k_{tlrr} = 0$), are shown in Figure 15. The lower graph shows the ankle joint angles of legs, by which we can see the three states of each leg, i.e., stance, swing and stumble as described in Section 2.1.

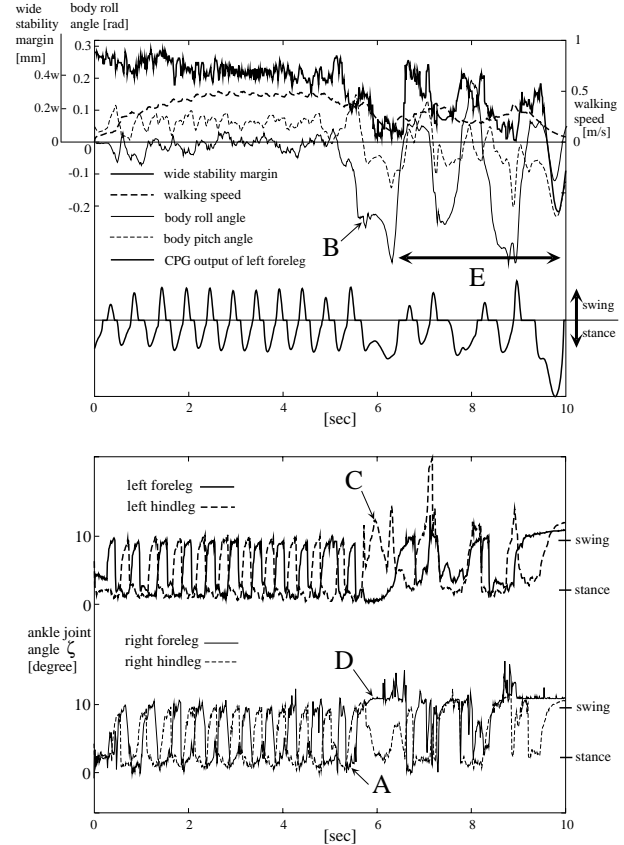

Fig. 15. An experiment of walking over a step 2 cm in height without a TLRR ($k_{tlrr} = 0$, $\tau = 0.04$, $\theta_{stance} = -0.8$). The right fore leg landed on the obstacle at (A) and lost contact with the obstacle afterwards at (D), since the body was inclined to the left too much at (B).

The right fore leg landed on the obstacle at 5.2 s (A in Figure 15) and the body was much inclined to the left (B). Since the left hind leg moved to a swing phase afterwards (C), Tekken tried to cancel the inclination of the body using the left fore leg only, but failed. As a result, the stable entrainment of CPGs with the pitching motion of the legs was lost, the amplitude of the rolling motion was increased, WSM often became small, and the gait was greatly disturbed (E).

5.2. Experiments with TLRR

Figure 16 shows the results of experiments, where Tekken walked over the same terrain as in Figure 15 with a TLRR ($k_{tlrr} = 3.3$).

The left hind leg stumbled on an obstacle (A in Figure 16). Since the left hind leg landed on the obstacle and dropped from the obstacle afterwards, the body was inclined to the left (B) at 5 s. In response to this inclination of the body, the stance phase of the left hind leg was extended (C), the swing phase of the left fore leg was shortened (D) and the

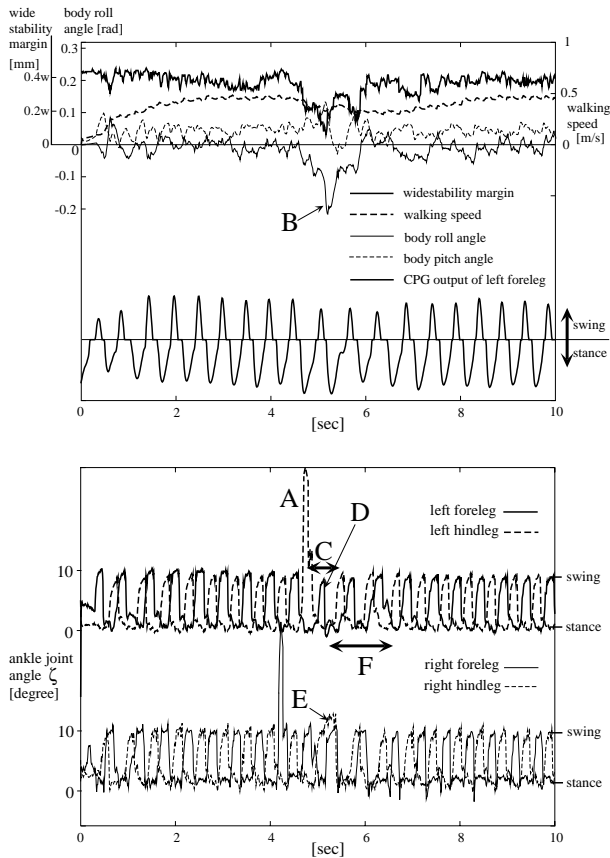

Fig. 16. An experiment of walking over a step 2 cm in height with a TLRR ($k_{tlrr} = 3.3$, $\tau = 0.04$, $\theta_{stance} = -0.8$).

swing phase of the right hind leg was extended (E) by the effect of a TLRR as described in Section 3.3. As the result of appropriate adjustment of the phases of the legs by a TLRR, the inclination of the body became small at 5.4 s and was canceled at 6 s. Finally, the gait returned to a trot gait again at 6.8 s via a walk gait (F). Consequently, it is shown that a TLRR is very effective to stabilize the gait and to keep high WSM on irregular terrain.

5.3. Experiments on Terrain of Medium Degree of Irregularity

We made Tekken walk on several irregular terrains (Figure 17) with eq. (8) and the fixed values of parameters shown in Tables 3 and 4. Tekken walked over an obstacle 4 cm in height² while stumbling and landing on the obstacle (Figure 18(a)). Tekken walked up and down a slope of 10° in the forward direction (Figures 17(a) and 18(b)), and walked over slopes of 3 and 5° in a sideways direction (Figures 17(e) and 18(c)) with an appropriate adjustment of periods of the stance and

2. Currently, the size of the passive ankle joint mechanism (Figure 1) limits the obstacle height as $\approx 20\%$ of leg length.

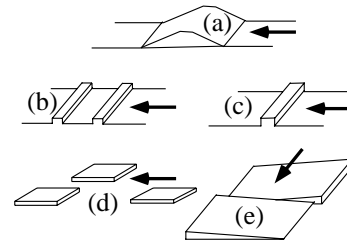

Fig. 17. (a), (b), (c) One-dimensional and (d), (e) two-dimensional irregular terrains.

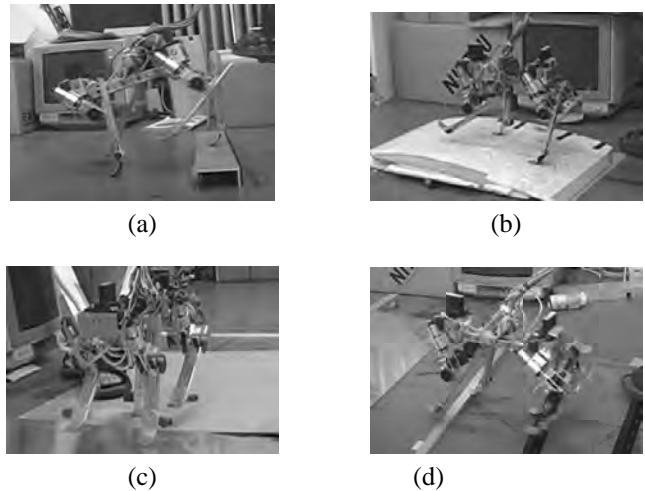

Fig. 18. Photographs of walking on irregular terrain: (a) walking over a step 4 cm in height; (b) walking up and down a slope of 10° in a forward direction; (c) walking over slopes of 3 and 5° in a sideways direction; (d) walking over a series of obstacles 2 cm in height.

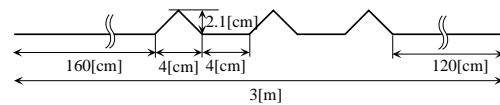

Fig. 19. Irregular terrain used for Figures 20 and 21.

swing phases. Tekken also walked over terrains consisting of several boards 1.5 cm in height (Figure 17(d)), and a series of obstacles (Figures 17(b) and 18(d)) with a speed of 0.7 m s^{-1} . Without a TLRR, the gait was greatly disturbed, even if Tekken did not fall down.

Consequently, it is shown that the method proposed in this study gives Tekken autonomous adaptation ability, since walking over unknown terrain of medium degree of irregularity has been realized with fixed values of parameters.

5.4. How to Obtain Good Performance on Irregular Terrain under Trade-off of Stability and Energy Consumption

In Section 4.3, we mentioned the trade-off problem between the stability and the energy consumption in order to determine the value of τ . In this study, we employ the following eq. (9) in order to change τ according to the WSM measured using joint angle sensors. Equation (9) means that we choose the large value of τ while the WSM is high in order to decrease the energy consumption, and we choose the small value of τ while the WSM is low in order to increase the WSM.

$$\tau = 0.12(\text{WSM})/w \quad (9)$$

where WSM is normalized by the body width of Tekken ($w = 120$ mm).

Figures 20 and 21 show the results of experiments, where Tekken walked over the terrain shown in Figure 19 with the small constant value of $\tau (= 0.005)$ and the various values of τ calculated using eq. (9).

In Figure 20, we can see that the minimum WSM for the constant value of τ is $\approx 0.25w$ on the irregular terrain and stable walking was obtained, since τ is very small. On the other hand, when walking with the various values of τ , the WSM became small ($0.18w$) on the irregular terrain at 9.3 s. But the relatively small values of $\tau (= 0.02)$ calculated by eq. (9) made the cyclic period of walking short instantly, increased WSM up to $0.25w$ and prevented Tekken from falling down. The walking with the large constant value of $\tau (= 0.05)$ became unstable on the irregular terrain.

In Figure 21, the energy consumption with the small constant value $\tau = 0.005$ is larger than that with the various values of τ (0.02 – 0.065) at the dominant walking speed (0.3 m s^{-1}). Since the energy consumption in area B corresponds to the instant energy consumed for adaptation to irregular terrain, the time integration of those energy is not large. As a result, the integration of the energy consumption was 1020 J when walking with the constant value of $\tau (= 0.005)$ and 650 J when walking with the various value of τ . Consequently, it was shown that stable walking with the low energy consumption was obtained using eq. (9).

6. Discussion

6.1. Coupled-dynamics-based Motion Generation

Motion generation based on biological concepts is illustrated as Figure 22(a), where a neural system and a mechanical system have their own nonlinear dynamics. The characteristic of this method is that there is no adaptation through motion planning. These two dynamic systems are coupled to each other, generating motion by interacting with the environment emergently and adaptively (Taga, Yamaguchi, and Shimizu 1991; Taga 1995). We call this method “coupled-dynamics-based motion generation”.

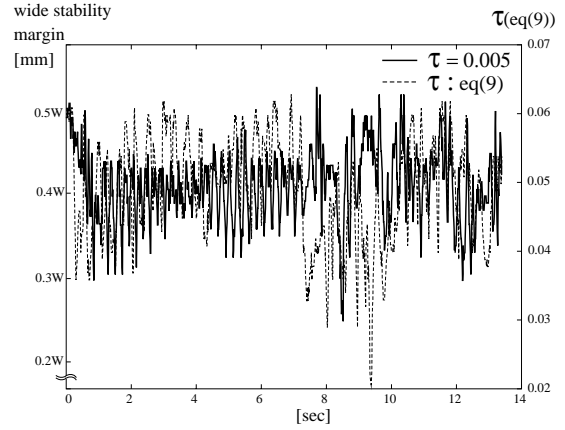

Fig. 20. WSM while walking over terrain shown in Figure 19 ($\theta_{stance} = -0.7$). The cyclic period of walking corresponding to the constant value $\tau = 0.005$ is ≈ 0.25 s. The cyclic period of walking corresponding to the various values of τ (0.02 – 0.065) is ≈ 0.32 – 0.7 s.

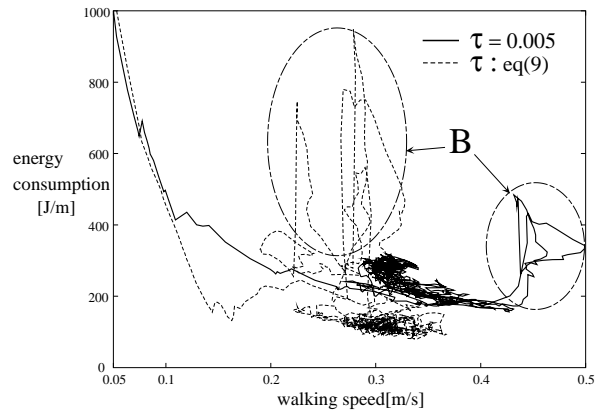

Fig. 21. Energy consumption while walking over terrain shown in Figure 19 with the constant value of $\tau (= 0.005)$ and the various values of τ calculated using eq. (9). The dominant walking speeds in both walks are almost equal ($\approx 0.3 \text{ m s}^{-1}$).

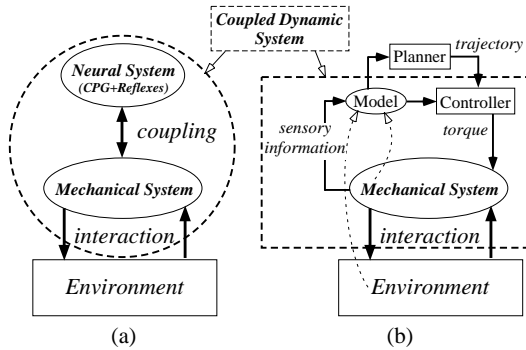

Fig. 22. Illustration of motion generation by (a) a neural system and (b) a conventional robotics system.

On the other hand, a control system in conventional robotics, such as impedance control, also constructs a coupled dynamic system with a mechanical system (Figure 22(b)). However, the motion planner is outside the coupled dynamic system. Basic motion generation and motion adaptation based on sensor information should be described as algorithms considering the dynamics of lower systems.

The coupled dynamic system can induce autonomous adaptation according to its own dynamics, under changes in the environment (e.g., adaptive walking on irregular terrain) and under adjustment of the neural system parameters by an upper-level controller (e.g., gait transition in change of walking speed). Therefore, we can avoid such serious problems in robotics as modeling of mechanical system and environment, autonomous planning, conflict between planned motion and actual motion and so on.

The most important subject in coupled-dynamics-based motion generation is to design and construct a neural system carefully, while taking into account the dynamics of a mechanical system and its interaction with the environment. In this study, we designed a neural system consisting of CPGs, responses and reflexes, while taking into account the characteristics of dynamic walking and utilizing knowledge and concepts in physics, biology, physiology and so on, as described in Sections 2.2–2.5. The relationship between parameters of CPGs and the mechanical system was previously analyzed to some extent (Kimura, Fukuoka et al. 2001). Since the relationship among parameters of responses, parameters of the virtual spring–damper system and the mechanical system has not yet been investigated, we manually determined the values of these parameters through experiments. The issue of how to construct a neural system suitable for a mechanical system corresponds to the issue of “embodiment” at the lowest level of sensorimotor coordination.

6.2. How to Design a Neural System for Locomotion

The study of the pattern generation and reflexes of insects, especially, cockroaches (Pearson 1976; Delcomyn 1999) and

stick insects (Cruse 1990; Pearson and Franklin 1984) has become particularly advanced because of the simplicity of their nervous systems. Simulations and experiments of the hexapod robots using knowledge obtained in such biological studies have been carried out (Beer, Chiel, and Sterling 1991; Eltze, Weidemann, and Pfeiffer 1992; Espenschied et al. 1996; Kimura, Yano, and Shimizu 1993). Especially, Espenschied et al. (1996) constructed the gait pattern generator proposed by Cruse (1990) referring to a stick insect. They also employed the swaying, stepping, elevator and searching reflexes observed by Pearson and Franklin (1984) in a stick insect, and realized statically stable autonomous walking of a hexapod robot on rough terrain.

In their gait pattern generator, the step pattern generator of each leg receives only sensor information of the adjacent legs. When the leg motion is changed by reflexes, the phase differences between legs are autonomously adjusted through sensor information of the leg. Consequently, their neural system is more sensor-dependent and more decentralized. However, since the pattern generator does not have its own cyclic period, the cyclic period of the walking is mainly determined by the body speed and the leg stride. Therefore, it is difficult to apply their neural system to the dynamic walking, in which there exists the upper bound of the cyclic period (Kimura, Shimoyama and Miura 1990).

On the other hand, we have constructed the neural system centering the NOs, since the exchange between the swing and stance phases in the short term and the quick adjustment of these phases on irregular terrain are essential in the dynamic walking of a quadruped where the unstable two-legged stance phase appears. The characteristics of our neural system in comparison with the neural system used by Espenschied et al. (1996) are as follows.

- The cyclic period and the gait are mainly determined by the time constant of CPGs and the connecting weights of the CPGs network, respectively, to some extent as described in Sections 4.1 and 4.2.
- As sensor feedback for adaptation on irregular terrain, responses directly and quickly modulating the CPG phase are employed in parallel with reflexes directly generating joint torque.

Cruse (2002) argued that such a central rhythm generator implying a “world model” in the form of a central oscillator could even cause the behavior to deteriorate in unpredictable situations. However, Delcomyn (1999) as well as Full and Koditschek (1999) mentioned the following points about the nervous systems of insects.

- American cockroaches ignore sensory input during fast running, and combine the output from CPGs with sensor information during slow or medium walking.
- The much slower walking stick insects require sensory

input at all times, since the centrally generated pattern is either extremely weak or nonexistent.

We also believe that we should use the appropriate control method or neural system according to the locomotion speed as already mentioned in Section 2 using Table 1.

7. Conclusion

In the neural system model proposed in this study, the relationships among CPGs, sensory input, reflexes and the mechanical system are simply defined, and motion generation and adaptation are emergently induced by the coupled dynamics of a neural system and a mechanical system by interacting with the environment. To generate appropriate adaptation, it is necessary to design both the neural system and the mechanical system carefully. In this study, we designed the neural system consisting of CPGs, responses, the stretch reflex and other reflexes referring to biological concepts. We also designed the passive spring-and-lock mechanism at the ankle joint as a mechanical implementation of the flexor reflex. The virtual spring-damper system became effective since Tekken had a light-weighted leg and high backdrivability in each joint.

The physical oscillations, such as the motion of the virtual spring-damper system of each leg and the rolling motion of the body, are mutually entrained with CPGs as the neural oscillations. A CPG receives sensory input and changes the period of its own active phase as responses. The virtual spring-damper system also receives sensory input and outputs torque as reflexes. The states in the virtual spring-damper system are switched based on the phase signal of the CPG. Consequently, adaptive walking is generated through the interaction with environment.

References

- Akazawa, K., Aldridge, J. W., Steeves, J. D., and Stein, R. B. 1982. Modulation of stretch reflexes during locomotion in the mesencephalic cat. *Journal of Physiology* 329:553–567.
- Beer, R. D., Chiel, H. J., and Sterling, L. S. 1991. An Artificial Insect. *American Scientist* 79:444–452.
- Buehler, M., Battaglia, R., Cocosco, A., Hawker, G., Sarkis, J., and Yamazaki, K. 1998. Scout: A simple quadruped that walks, climbs and runs. In *Proc. ICRA1998*, pp. 1707–1712.
- Cham, J. G., Karpick, J., Clark J. E., and Cutkosky, M. R. 2001. Stride period adaptation for a biomimetic running hexapod. In *Proc. ISRR2001*, pp. 77–87.
- Chew, C. M., Pratt, J., and Pratt, G. 1999. Blind walking of a planar bipedal robot on sloped terrain. In *Proc. ICRA99*, pp. 381–386.
- Cohen, A. H., and Boothe, D. L. 1999. Sensorimotor interactions during locomotion: principles derived from biological systems. *Autonomous Robots* 7(3):239–245.
- Cruse, H. 1990. What mechanism coordinate leg movement in walking arthropods? *Trends in Neurosciences* 12:15–21.
- Cruse, H. 2002. The functional sense of central oscillations in walking. *Biological Cybernetics* 86:271–280.
- Dean J., Kindermann, T., Schmitz, J., Schumm, M., and Cruse, H. 1999. Control of walking in the stick insect: From behavior and physiology to modeling. *Autonomous Robots* 7(3):271–288.
- Delcomyn, F. 1999. Walking robots and the central and peripheral control of locomotion in insects. *Autonomous Robots* 7(3):259–270.
- Eltze, J., Weidemann, H. J., and Pfeiffer, F. 1992. Design of walking machines using biological principles. In *Proc. IFToMM-jc*, pp. 689–694.
- Espenschied, K. S., Quinn, R. D., Beer, R. D., and Chiel, H. J. 1996. Biologically based distributed control and local reflexes improve rough terrain locomotion in a hexapod robot. *Robotics and Autonomous Systems* 18:59–64.
- Full, R. J., and Koditschek, D. E. 1999. Templates and anchors: neuromechanical hypotheses of legged locomotion on land. *Journal of Experimental Biology* 202:3325–3332.
- Full, R. J. 2000. Biological inspiration: lessons from many-legged locomotors. *Robotics Research 9*, Hollerbach, J. M. and Koditschek, D. E., eds, Springer, London, pp. 337–341.
- Ghez, C. 1991. Posture, Principles of Neural Science 3rd edn, Kandel, E. R., Schwartz, J. H., and Jessell, T. M., eds, Appleton & Lange, Norwalk, CT, p. 601.
- Grillner, S. 1981. Control of locomotion in bipeds, tetrapods and fish. *Handbook of Physiology II* American Physiology Society, Bethesda, MD, pp. 1179–1236.
- Hodgins, J. K., and Raibert, M. H. 1991. Adjusting step length for rough terrain locomotion. *IEEE Transactions on Robotics and Automation* 7(3):289–298.
- Ijspeert, A. J. 2001. A connectionist central pattern generator for the aquatic and terrestrial gaits of a simulated salamander. *Biological Cybernetics* 84:331–348.
- Ilg, W., Albiez, J., Jeede, H., Berns, K., and Dillmann, R. 1999. Adaptive periodic movement control for the four legged walking machine BISAM. In *Proc. ICRA1999*, pp. 2354–2359.
- Kajita, S., and Tani, K. 1996. Adaptive gait control of a biped robot based on real-time sensing of the ground. In *Proc. ICRA1996*, pp. 570–577.
- Kimura, H., Shimoyama, I., and Miura, H. 1990. Dynamics in the dynamic walk of a quadruped robot. *Advanced Robotics* 4(3):283–301.
- Kimura, H., Akiyama, S., and Sakurama, K. 1999. Realization of dynamic walking and running of the quadruped using neural oscillator. *Autonomous Robots* 7(3):247–258.
- Kimura, H., Fukuoka, Y., and Konaga, K. 2001a. Adaptive dynamic walking of a quadruped robot using neural system model. *Advanced Robotics* 15(8):859–876.

- Kimura, H., Fukuoka, Y., Hada, Y., and Takase, K. 2001b. 3D adaptive dynamic walking of a quadruped robot by using neural system model. In *Proc. CLAWAR2001*, pp. 97–104.
- Kimura, S., Yano, M., and Shimizu, H. 1993. A Self-Organizing Model of Walking Patterns of Insects, *Biological Cybernetics* 69:183–193.
- Lewis, M. A., Etienne-Cummings, Hartmann, M. J., Xu, Z. R., and Cohen, A. H. 2003. An in silico central pattern generator: silicon oscillator, coupling, entrainment, and physical computation. *Biological Cybernetics* 88:137–151.
- Matsuoka, K. 1987. Mechanisms of frequency and pattern control in the neural rhythm generators. *Biological Cybernetics* 56:345–353.
- Miura, H., and Shimoyama, I. 1984. Dynamical walk of biped locomotion. *International Journal of Robotics Research* 3(2):60–74.
- Miyakoshi, S., Taga, G., Kuniyoshi, Y., and Nagakubo, A. 1998. Three-dimensional bipedal stepping motion using neural oscillators—Towards humanoid motion in the real world. In *Proc. IRSO1998*, pp. 84–89.
- Ogawa, T. et al., eds. 1998. *Nanzando's Medical Dictionary* 18th edn, Nanzando, Tokyo, p. 1211 (in Japanese).
- Pearson, K. G. 1976. The control of walking. *Scientific American* 234(6):72–87.
- Pearson, K. G., and Franklin, R. 1984. Characteristics of leg movements and patterns of coordination in locusts walking on rough terrain. *International Journal of Robotics Research* 3:101–112.
- Saranli, U., Buehler, M., and Koditschek, D. E. 2001. RHex: a simple and highly mobile hexapod robot. *International Journal of Robotics Research* 20(7):616–631.
- Taga, G., Yamaguchi, Y., and Shimizu, H. 1991. Self-organized control of bipedal locomotion by neural oscillators. *Biological Cybernetics* 65:147–159.
- Taga, G. 1995. A model of the neuro-musculo-skeletal system for human locomotion II. Real-time adaptability under various constraints. *Biological Cybernetics* 73:113–121.
- Takanishi, A., Takeya, T., Karaki, H., and Kato, I. 1990. A control method for dynamic biped walking under unknown external force. In *Proc. IRSO1990*, pp. 795–801.
- Tsujita, K., Tsuchiya, K., and Onat, A. 2001. Adaptive Gait Pattern Control of a Quadruped Locomotion Robot. In *Proc. IROS2001*, pp. 2318–2325.
- Yamaguchi, J., Takanishi, A., and Kato, I. 1994. Development of a biped walking robot adapting to a horizontally uneven surface. In *Proc. IRSO1994*, pp. 1156–1163.
- Yoneda, K., Iiyama, H., and Hirose, S. 1994. Sky-hook suspension control of a quadruped walking vehicle. In *Proc. ICRA1994*, pp. 999–1004.