

Fractal Analysis and Modeling of VoIP Traffic*

Trang Dinh Dang, Balázs Sonkoly, Sándor Molnár

High Speed Networks Lab, Dept. of Telecommunications & Media Informatics

Budapest Univ. of Technology & Economics, H-1117, Magyar tudósok körútja 2, Budapest, Hungary

Tel: (361) 463 3889, Fax: (361) 463 3107, E-mail: {trang, sonkoly, molnar}@tmit.bme.hu

Abstract

In this paper a fractal analysis study of VoIP traffic is presented. The characteristics of measured VoIP traffic on both call and packet level have been investigated. The results support the popular Poisson process for VoIP call arrival modeling but we argue that the call holding times follow heavy-tailed distributions rather than exponential distributions. We propose the generalized Pareto distribution for modeling the call holding times. At the packet level we have found that the exponential modeling of On and Off periods is also inappropriate and heavy-tailed characteristics have been identified in case of all the investigated VoIP codecs. The generalized Pareto distribution can be used as an accurate model for the On and Off periods too. In the analysis we revealed that the aggregated VoIP traffic has fractal characteristics and we suggest the fractional Gaussian noise model for the aggregated VoIP traffic.

1 Introduction

One of the most important service of today's communication networks is voice service. There are a number of benefits of Voice over Internet Protocol (VoIP) which underline the importance of VoIP: reduced communication cost, the use of the integrated IP infrastructure, participating in a multimedia application, etc. VoIP can also utilize the advantages of packet-switched networks, e.g. high network utilization while keeping the quality of circuit-switched networks [10, 13]. However, the best-effort nature of IP networks can not guarantee the requirements of delay sensitive voice traffic. VoIP network management is needed to support QoS for VoIP applications. The design and performance analysis of VoIP QoS techniques requires adequate traffic models which is the target of this paper.

The characteristics of traffic originated from a single voice source is significantly affected by the applied voice coder (codec). We can distinguish two classes of voice streams generated by different codecs. The first group covers the constant bit rate traffic streams

(e.g. G.711) and in the other group we have voice traffic streams produced by codecs using silence compression and generating active (On) and inactive (Off) periods alternately (e.g. G.723.1, G.729 B, GSMFR) [17]. From a modeling point of view, the second group has importance so we are dealing with VoIP traffic models of On-Off type voice codecs.

The issue of modeling packetized voice traffic is not a new subject and it has been addressed in a number of papers in the teletraffic literature. In [1] the technique of classical voice activity detection (VAD) is presented, where the parameters are set to fix values. The traffic of a codec based on classical VAD algorithms consists of talkspurts and gaps and the length of these periods can be well modeled by exponential distribution which implies a simple two-state Markov model for a single voice source. Referring to previous works [15, 7, 14] and [6] apply this classical source model, e.g. in [14] and [6] the parameters used give 650 ms mean value for gap durations and 352 ms for talkspurt durations, respectively. Hence, the number of packets arriving at constant packet rate (1 packet per 16 ms) in an On period is geometrically distributed with mean 22.

In spite of the fact that the classical exponential On-Off model is simple and tractable, past speech measurements have indicated that gap distributions do not always fit well to exponential distributions [2, 5]. Furthermore, modern voice codecs and silence detectors operate on a different basis and allow some parameters to be changed adaptively during the operation. In [8] two silence detectors (G.729 Annex B VAD [17] and NeVoT Silence Detector [11]) and the effect of some parameters (such as threshold, hangover time, etc.) on the On-Off model have been examined. As a result, the authors have revealed that the lengths of On and Off periods are failed to be modeled by the exponential distributions. A similar research [3] indicates that lognormal distribution gives a better fit to measured VoIP traces. Another On-Off model has been presented in [12], where the On and Off periods are approximated by gamma and Weibull distributions, respectively.

The performance analysis of VoIP traffic includes the analysis of the appropriate queueing model. In the queueing system the queues are fed by an aggregated traffic which is originated by multiplexing traffic of in-

*This work was supported by the Ministry of Education, Hungary under the reference No. IKTA-0092/2002

coming links and the incoming packets will be served according to the applied service discipline. In case of exclusive voice streams the FCFS (First Come First Served) service discipline can be adequate. However, if the links are shared between data and voice packets priority scheduling has to be applied. In order to derive the analytical results for a queueing system (e.g. distribution of waiting times of packets in the queue), a simple, tractable and accurate approximation for aggregate packet arrival process is required. One of the simplest models is the Poisson model which has been widely applied in classical teletraffic modeling. However, the traffic of data networks possesses different characteristics resulting that the Poisson approximation will be acceptable only under special conditions.

Eckberg has derived the exact delay distribution for a $\sum_i D_i/D/1$ queueing system providing the ability of a worst-case analysis in [4]. The applied source model is based on a periodic and deterministic arrival process (not On-Off model) and service times are also deterministic assuming the maximum packet size. Eckberg has compared the results with the results of classical $M/D/1$ queue (Poisson arrival process, deterministic service time) and a finite source version of that ($M/D/1/N$) and concluded that if the incoming trunks are lightly utilized, then the $M/D/1$ and $M/D/1/N$ approximations fit well to his model, but in case of fully utilized links the error from these approximations can be substantial.

Stern has presented a queueing model based on the exponential On-Off model and an imbedded continuous time Markov chain whose states represent the number of currently active speakers in [15]. The queue length probability distribution for the system determining the ergodic probabilities of a specially constructed imbedded Markov chain has analytically derived in this paper.

Three different approximations for aggregate arrival process based on exponential On-Off sources has been compared with simulations and the delay performance in a statistical multiplexer has been examined in [7]. Having compared the Poisson, a Markovian and a renewal model, it has been shown that for traffic intensity less than 0.7 the Poisson approximation meets the simulation results, but in case of higher intensity the combined traffic behaves significantly different from a Poisson stream. Whereas, the renewal model ($GI/D/1$ queue) has been found to provide accurate and robust approximation to the mean waiting times of packets in the statistical multiplexer for all traffic intensities.

Sriram and Whitt has extended Jenq's analysis [7] on renewal model to shared voice and data traffic in [14]. A $\sum_i GI_i/G/1$ queueing model has been established and an approximation model (QNA, Queueing Network Analyzer [16]) has been examined. With QNA technique, the superposition arrival process is characterized by two parameters, one representing the average arrival rate and the other the variability. [14] has demonstrated that de-

pendence among interarrival times can play an essential role and the long-term positive dependence is a major cause of congestion in the multiplexer queue under heavy loads resulting the failure of the classical $M/D/1$ model.

Heffes and Lucantoni has proposed an $MMPP/G/1$ queueing model in [6], where the aggregate input traffic consisting of voice and data packets is approximated by a correlated Markov modulated Poisson process (MMPP). Matrix analytic methods are then used to evaluate system performance measures, such as moments of voice and data delay distributions and queue length distributions. The numerical results for the tails of voice packet delay distribution show the dramatic effect of traffic variability and correlations on performance which cannot be captured by Poisson model.

Karam and Tobagi has compared different scheduling schemes in [9] and concluded that Priority Queueing (PQ) is the most appropriate service discipline for handling voice traffic, while preemption of non-voice packets is strongly recommended for sub-10 Mbit/s links.

The presented research results on VoIP traffic modeling were carried out in the research framework of the IKTA project sponsored by the Hungarian Ministry of Education. We have collected and analyzed VoIP traffic traces measured in some actual VoIP network scenarios in the Hungarian network environment. We have investigated the characteristics of VoIP calls in a private network scenario. Our aim was to find adequate stochastic models for the arrival process of calls and the call holding time. The results show that the call arrivals can be well modeled by the Poisson process while the call holding times are well fitted to the generalized Pareto distribution.

We have also done an exhaustive analysis on On-Off sources regarding different speech codecs and derived that codecs using Voice Activity Detectors (VAD) which are featured with dynamic and adaptive coding mechanism, do not show the same behavior as the classical ones. Our analysis shows that the lengths of On and Off periods are failed to be modeled by the exponential distributions. The results suggest the use of heavy-tailed distributions. We have proposed the generalized Pareto distribution for modeling of On and Off periods.

It is a known fact that traffic aggregation of a large number of heavy-tailed On-Off sources is self-similar, thus our next step was to investigate the VoIP aggregate from this aspect. We have carried out a simulation study using the measured call-level statistics and the real On-Off traces. The results show that in case of high load the Poisson model does not agree with the simulations and the aggregated process is strongly correlated and exhibit long-range dependent properties. In addition, the packet arrival counts have similar characteristics at different aggregation levels. These findings indicate the possibility of self-similarity. We have carried out different self-similarity tests for different configurations and

concluded that the self-similar property of the aggregate traffic has to be taken into account in modeling in case of high call arrival intensity. Moreover, we have proposed the Fractional Gaussian Noise for aggregate VoIP modeling.

The paper is organized as follows: in Section 2, we present the call-level measurements, the collected traces and the environment of packet-level source measurements. In Section 3 we describe the call-level and packet-level analysis and the applied statistical methods. After that, in Section 4, the simulation environment of traffic aggregation and basic conceptions are presented with the results of statistical analysis and self-similarity tests. Finally, in Section 5, we summarize the results and outline our future plans about further research.

2 Measurements

VoIP traffic measurements are briefly presented in this section.

2.1 Call-level measurements

Call-level traffic traces were collected from a corporate VoIP networks, which consist of approximately 800 VoIP phones. Our analysis was based on 'Call Detail Records' (CDRs) generated by a Cisco CallManager Release 3.3(2) system. This type of information can be used to post-processing activities such as generating billing records and network analysis. CDRs include 51 fields such as IP address and port number of originating and destination stations, calling and called party numbers, type of used codecs, timestamp of connections, disconnections, and duration of calls. The call arrival and duration information, which are relevant to call-level modeling, were derived from the CDR database and gave the input for our statistical analysis. The CDR records were measured continuously from 18th November 2002 to 16th July 2003.

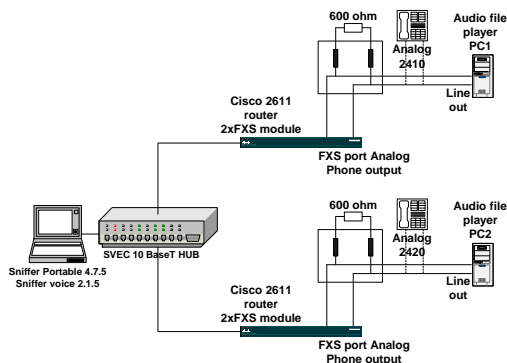

Figure 1: Measurement of packet-level VoIP traffic.

We also intended to measure packet-level traffic in this network environment. Unfortunately, the VoIP ser-

vice is operated without voice codecs using Voice Activity Detection (VAD). In other hand our analysis also requires the traffic generated by different voice codecs to examine their impacts on the characteristics of the traffic. Thus, in order to measure packet-level traffic, we have set up a measurement scenario at the Department of Telecommunications and Media Informatics, Budapest University of Technology and Economics, which is shown in the followings.

2.2 Measurements of individual voice sources

Measurements of individual packetized voice sources have been carried out in the laboratory network environment presented in Figure 1.

We claimed students and PhD. students to make phone calls for this goal. Two directions of their conversations were recorded separately and then replayed to our laboratory VoIP phones. The VoIP connection was implemented between two Cisco 2611 routers. The traffic between the two routers was captured by a Network Associates Sniffer Portable 4.7.5 equipment with Sniffer Voice module version 2.1.5.

We examined the traffic of G.723.1, G.729B, and GSMFR codecs with VAD activated. (In Cisco VoIP systems, VAD and the type of applied codecs can be configured independently.) The settings of voice codecs and VAD were the default values of Cisco VoIP systems. The packet streams were collected for later analysis.

3 Analysis

In this section, we summarize the main results revealed by the statistical analysis of the measured VoIP traffic traces. The analysis studies were carried out for both call- and packet level traffic.

3.1 Call-level analysis

Our call-level analysis means the investigation studies of two call related processes: the call arrival and the call holding time process. The analysis has been carried out in the Matlab environment, partly using the functions of the Wafo toolbox [19].

Statistics	Call i.a. time	Call holdings
No. of samples	4 733	464 161
Mean [s]	6.0830	114.2701
Variance	55.5998	36,904

Table 1: Basic statistics for call interarrivals and call holding times (sec)

Table 1 presents the basic statistics of the measured call interarrival and holding time data series. The call

interarrival data was selected from a busy period of a representative working day (analysis of day 211 is illustrated in this paper), where the call traffic is nearly stationary. The call holding times can be considered independent of days, thus all reported holding times of over 240 working days were used for analysis.

These two processes were fitted with different distributions. The results are given in Figure 2. It is seen in Figure 2(a) that the call interarrival times are fitted well by the exponential distribution with parameter $\lambda = 0.164$. Moreover, the autocorrelation function created from the data showed that the interarrival times can be considered independent. These indicate that the well-known Poisson model is accurate for the call arrival process. Similar results were observed in the analysis of different working days.

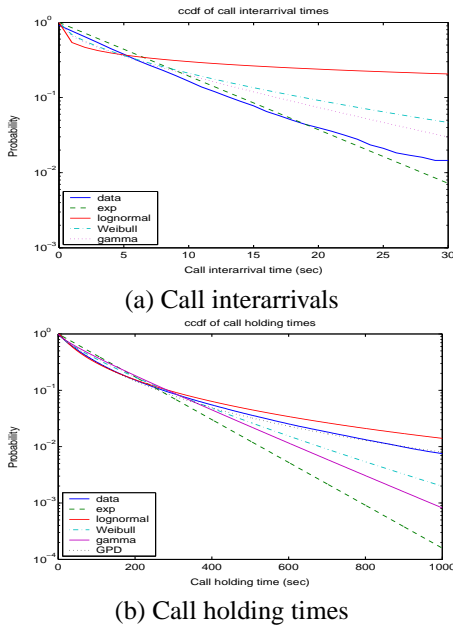

Figure 2: Distribution fitting of call-level processes.

Interesting result was obtained in the analysis of call holding time series. Classical models of VoIP traffic often assume the exponential distribution for the call holding process. In our case, we found that the tail of the empirical distribution of the call holding times decays much slower than the exponential. As presented in Figure 2(b) the tail distribution, strictly speaking, the complementary cumulative distribution function (ccdf) of the data clearly has the power decay in contrast with the linear decay of the exponential. Note that the ccdf-s are plotted in the log-linear scales.

We then tried to fit the data with distributions of different tail decays. The lognormal, Weibull, gamma, and Pareto distribution [18] were considered and the results are also shown in Figure 2(b). We observed that the generalized version of the Pareto distribution (GPD) provides the best fit to the data. The estimated values for the parameter set of the GPD were $(k, s) = (-0.39, 69.33)$,

where k is the shape parameter and s is the scale parameter of the GPD. Note that the cdf of the GPD is given by:

$$F(x) = \begin{cases} 1 - \left(1 - \frac{k(x-m)}{s}\right)^{\frac{1}{k}} & \text{if } k \neq 0 \\ 1 - e^{-\frac{x-m}{s}} & \text{otherwise,} \end{cases}$$

where the location parameter m is set to be 0 in our analysis.

Our call-level analysis shows that while the call arrival process can be well modeled by the Poisson distribution, the exponential model fails to capture the characteristics of the call holding times. Instead, we suggest the use of the Pareto distribution for the modeling of this process.

3.2 Packet-level analysis

In the next step we have investigated the characteristics of packetized voice streams. As mentioned above, voice sources of three different codecs, i.e. G.723, G.729B and GSMFR, with Voice Activity Detection (VAD) included were reported in our measurements. The voice sources were processed and the length of On and Off periods in the voice sources was calculated from the raw packet streams. The basic statistics of On and Off lengths are given in Table 2. We should mention that the means of On/Off periods depend on the setting of the VAD. In our measurements we used the default settings of Cisco VAD implementation.

The empirical ccdf-s for On and Off lengths are presented in Figure 3. We can see that the ccdf curves of different codecs have the same shape and they almost coincide with each other. This means that the voice codecs have very small impact on the main characteristics of On (Off) periods in the packetized sources. In fact, we suggest that the implementation of VAD seems to be the most important factor to be considered in VoIP modeling.

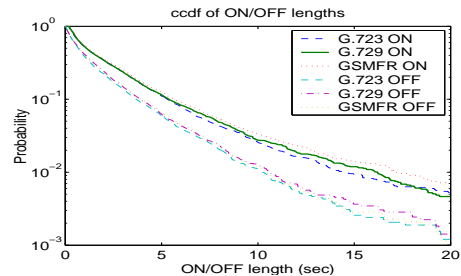

Figure 3: Empirical ccdf of On/Off lengths for investigated voice codecs.

Another finding of Figure 3 is that the On (Off) lengths do not have exponential distribution as classical VoIP models assume. In the log-linear plot, the ccdf curves should be straight lines in those cases. Instead,

Basic statistics	G.723		G.729		GSMFR	
	ON	OFF	ON	OFF	ON	OFF
Mean [s]	2.2822	1.4849	2.3651	1.5621	2.5014	1.5529
Variance	12.7700	5.9242	18.3193	5.1920	21.5190	5.1014

Table 2: Basic statistics of On and Off lengths for G.723, G.729 and GSMFR codecs.

we found that the measured On (Off) lengths may have heavy-tailed distribution.

The On (Off) data sets have been fitted by different distributions. We present in Figure 4 the G.729 case as an illustration. The results were similar for three investigated codecs. Our analysis showed that the GPD gives the best fit to the data sets of both On and Off lengths, see Figure 4(a) and (b). The parameter set (k, s) of the GPD was estimated to be $(-0.28, 1.7)$ and $(-0.35, 1.02)$ for On and Off lengths, respectively. These results were verified by the quantile-quantile plots presented in Figure 4(c) and (d).

Our findings show that the available VoIP aggregation models, which are based on the exponential distributions of On and Off lengths in the voice sources, cannot be applied. These distributions are clearly not exponential and the heavy-tailed GPD seems to be the accurate model to be used in our case. It is a known fact that the aggregate of many On/Off sources with heavy-tailed On and/or Off distribution is self-similar [20]. Therefore the self-similar model is a straightforward approximation for the VoIP traffic aggregation. The long-range dependent (LRD) and self-similar analysis of VoIP aggregation are shown in the next section.

4 Self-similar analysis of VoIP aggregation

As we have discussed in the previous section the experienced heavy-tailed distributions of On and Off periods in a single packetized voice source suggest an obvious model for VoIP aggregation traffic: the self-similar model. The detailed analysis of self-similarity is presented in this section.

4.1 Mathematical background of self-similarity

We first give an brief overview of self-similar processes and some widely used self-similar statistical tests which are applied later in this section.

The real-valued process $\{Y(t), t \in \mathbf{R}\}$ is self-similar with index $H > 0$ (H-ss) if for all $a > 0$, $Y(at) \stackrel{d}{=} a^H Y(t)$. A non-degenerate H-ss process cannot be stationary because if it were, we would have for any $a > 0$ and $t > 0$, $Y(t) \stackrel{d}{=} Y(at) \stackrel{d}{=} a^H Y(t)$ and we would obtain a contradiction because $a^H Y(t) \rightarrow \infty$ as $a \rightarrow \infty$.

The process $\{Y(t), t \in \mathbf{R}\}$ is called H -sssi if it is self-similar with index H and has stationary increments.

If $\{Y(t)\}$ is a (non-degenerate) H -sssi finite variance process, then $0 < H \leq 1$. The increment sequence of $\{Y(t)\}$ in discrete time can be defined as $X_k = Y(k) - Y(k-1)$, $k = 1, 2, \dots$. Denote the m -aggregated time series of X and its autocorrelation function by $X^{(m)}$, $X_k^{(m)} = \frac{1}{m} \sum_{i=(k-1)m+1}^{km} X_i$, and $r^{(m)}(\cdot)$, respectively.

The interesting range of H is $0.5 < H < 1$ for traffic modeling because H -sssi $Y(t)$ processes with $H < 0$ are not measurable and represent pathological cases while for the $H > 1$ case the autocorrelation of the incremental process does not exist. The range of $0 < H < 0.5$ can also be excluded from our practice because in this case the incremental process is SRD. For practical purposes the range of $0.5 < H < 1$ is only important. In this range the autocorrelation of the incremental process is $r(k) = \frac{1}{2}[(k+1)^{2H} - 2k^{2H} + (k-1)^{2H}]$. This incremental process is LRD which shows the connection between self-similar and long-range dependent processes.

For an exactly (second-order) self-similar process

$$\text{var}(X^{(m)}) = \frac{1}{m^{2-2H}} \text{var}(X), \quad (1)$$

$$r^{(m)}(k) = r(k). \quad (2)$$

A weaker condition is the following: A process X is said to be asymptotically (second-order) self-similar if for all k large enough

$$\lim_{m \rightarrow \infty} r^{(m)}(k) = r(k). \quad (3)$$

The only Gaussian process that is self-similar and has stationary increments is called fractional Brownian motion (fBm) and its increment process is referred to as fractional Gaussian noise (fGn).

There are methods developed for testing of self-similarity and also for estimation of the Hurst parameter H . We applied in this paper three widely used tests: the variance-time plot, the R/S analysis, and the periodogram. More detailed description of self-similarity and related statistical tests can be found in [22] and references therein. x

4.2 Simulation and analysis

We then investigated the measured aggregated VoIP traffic. The data traces were selected from the busy periods

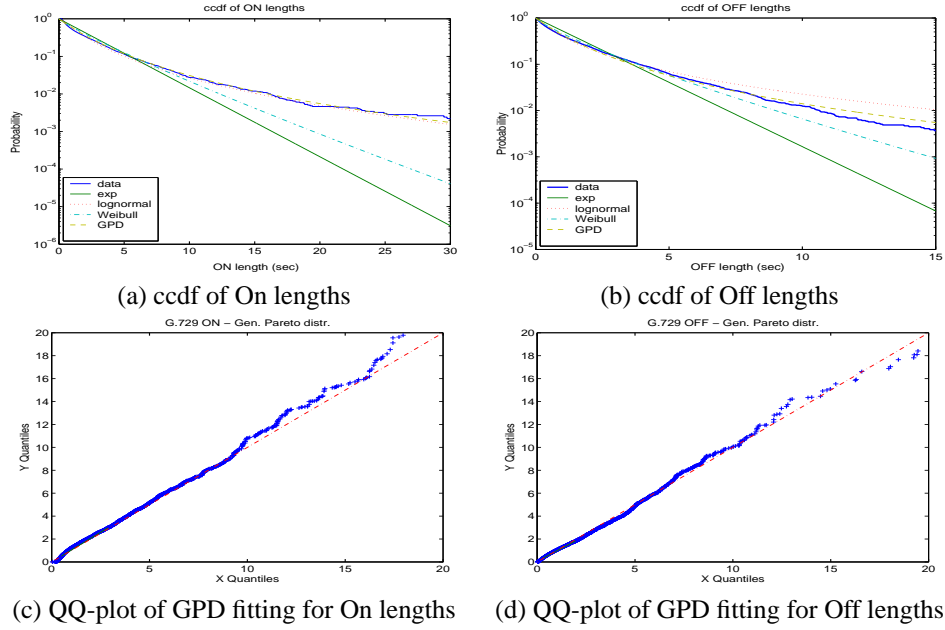

Figure 4: Distribution fitting of On and Off lengths for G.729 codec.

of the measured traces. Unfortunately, even the measurements were carried out at one of the biggest corporation VoIP network in Hungary, the busiest aggregation VoIP traffic contains only 35-45 parallel VoIP streams. In this case, we found that even the distributions of On and Off periods in a voice stream are heavy-tailed (discussed in the previous section), which are definitely far from the assumptions of these distributions to be exponential in classical VoIP traffic models, the aggregate still fits well the Poisson model. An example of this result is shown in Figure 5. We can observe that the measured packet interarrival time can be accurately fitted to the exponential distribution which indicates the Poisson model for the arrival process.

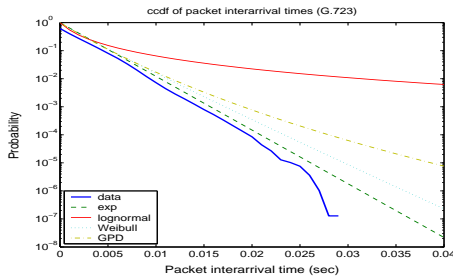

Figure 5: Distribution fitting of packet interarrival times of day 211 (G.723 codec).

In order to get the busier VoIP traffic aggregation we have performed several simulations with settings follow exactly the analyzed real traffic measurements. The VoIP call arrival process was also chosen to be Poisson but with larger call intensity. The call durations are generated from the generalized Pareto distribution with

parameters are the values estimated from the measured traces. Each call is then 'packetized' by alternate insertions of On and Off time periods until its end. The On and Off periods are randomly picked from the sets of measured On and Off data regarding the actual voice codec. The simulations were performed in 8 hour long. We generated from the raw data the packet count process of 100ms intervals for analysis.

The analysis results for the case of G.723 codec are the followings. The λ parameter of the Poisson call arrival process was 8.33, which means about 900 parallel voice streams in the aggregation at a time. Our statistical analysis showed that the obtained packet count series fails to fit the Poisson model. We calculated the autocorrelation function for the data series and found that it is strongly correlated and may have LRD structure. Thus several LRD tests, i.e. the variance-time plot, the R/S analysis, and the periodogram test, were applied to the data series. The results of these tests are presented in Figure 6.

Voice codec	VT plot	R/S	Periodogram
G.723	0.94	0.91	0.93
G.729	0.94	0.91	0.94
GSM FR	0.94	0.92	0.91

Table 3: Summary of LRD analysis of VoIP traffic aggregation for different voice codecs.

The variance-time plot shows that the data series may have two scaling intervals with the breakpoint is somewhere around the aggregation levels from 7 to 10, which is equivalent to timescales from 700ms to 1s. However, since LRD is an asymptotic property the scaling at large

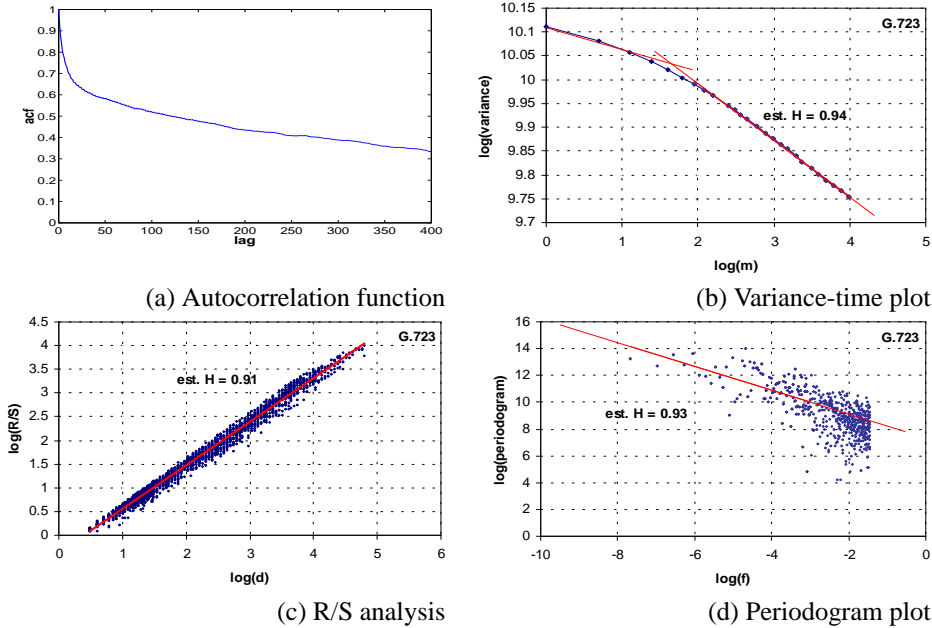

Figure 6: LRD tests for VoIP aggregation with G.723 codec.

timescales should be taken into account which results in estimation of Hurst parameter is 0.94. In the case of R/S plot points are clearly clustered around a linear line which suggests the presence of LRD with $H = 0.91$. This result was also justified by the periodogram test, H was estimated to be 0.95 in this case.

Similar simulations were done with G.729 and GSMFR voice codecs. The obtained aggregation traffic also exhibits LRD and self-similar properties in LRD tests as we expected. The detailed results of these tests are summarized in Table 3. Our results show that the used voice codec have negligible impact on the estimated Hurst parameter. In fact, we suppose that the improvements in VAD technique like dynamic energy threshold and dynamic hangover time seem to be the original causes of LRD VoIP traffic.

We also interested in how the intensity of the aggregation traffic effects the LRD properties of the aggregation. For this goal we run the same simulation scenario with several different intensities of call arrivals. LRD tests applied to the reported traffic showed the presence of LRD with almost the same values for H . Thus we can conclude that the intensity of the call arrival has no effects on the Hurst parameter of LRD.

4.3 A proposed model for VoIP traffic

Knowing the self-similar properties of VoIP traffic, there exist several self-similar processes which can be applied to model the traffic [22]. We propose here, for example, one of the simplest way to model self-similar traffic using fractional Gaussian noise (fGn). The model is given by:

$$X(t) = m + \sigma Z_H(t), \quad (4)$$

where $Z_H(t)$ denotes the fGn with Hurst parameter H , m and σ are the mean and the standard deviation of the model since fGn is a centralized normal process. Thus the model has altogether three parameters m , σ , and H .

The illustration use of the model is shown by applying it to the G.723 aggregate traffic presented above. m and σ are estimated from the data to be 1938.5 [packet] and 79.635, respectively. The estimate of the Hurst parameter of the data is about 0.93 in our previous LRD test. A comparison between the datagrams of the G.723 data and its simulation given by the model is shown in Figure 7. It is seen that the model data closely resemble the traffic.

5 Conclusion

In this paper we have presented a comprehensive study of VoIP traffic at both call- and packet level. It has been shown that some widely used models of VoIP traffic failed to capture the actual characteristics of the measured traces. We have found that while the call arrival process is still well-modeled by the Poisson model, the call holding times have heavy-tailed distributions. We also showed that the On and Off periods in a packetized model of voice sources can be modeled accurately by the generalized Pareto distribution. Based on these findings the fractal nature of VoIP traffic aggregation can be expected. We have verified this assumption by a fractal analysis and proposed the fractional Gaussian noise model for the aggregated VoIP traffic.

We have observed that an application like VoIP alone can cause the fractal properties to the aggregated traffic. In addition, the fractal characteristics of a data flow can

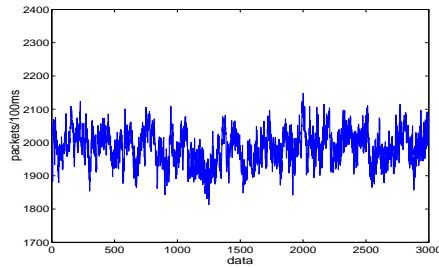

(a) G.723 data trace

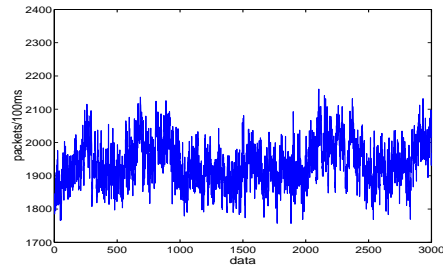

(b) Simulation of G.723 trace by the fGn model

Figure 7: Datagrams of the G.723 aggregate and its simulation by the fGn model.

‘infect’ and be passed to other flows due to the adaptation property of TCP [21]. Thus the origins of the fractal nature of the Internet traffic may lie on applications and not only on the mechanism of TCP protocols. However, a detailed and comprehensive studies are required to verify this conjecture.

References

- [1] P. T. Brady, "A Technique for Investigating On-Off Patterns of Speech", *Bell System Technical Journal*, 44(1):1–22, January 1965.
- [2] P. T. Brady, "A Statistical Analysis of On-Off Patterns In 16 Conversations", *Bell System Technical Journal*, 47(1):73–91, January 1968.
- [3] E. Casilari, H. Montes, and F. Sandoval, "Modelling of Voice Traffic Over IP Networks", CSNDSP 2002, Network Communications K1.5, July 2002.
- [4] A. E. Eckberg, "The Single Server Queue with Periodic Arrival Process and Deterministic Service Times", *IEEE Transactions on Communications*, Vol. COM-27, No. 3, pp. 556–562, March 1979.
- [5] J. G. Gruber, "A Comparison of Measured and Calculated Speech Temporal Parameters Relevant To Speech Activity Detection", *IEEE Transactions on Communications*, Vol. COM-30, No. 4, pp. 728–738, April 1982.
- [6] H. Heffes, D. M. Lucantoni, "A Markov Modulated Characterization of Packetized Voice and Data Traffic and Related Statistical Multiplexer Performance", *IEEE Journal on Selected Areas in Communications*, SAC-4(6):856–868, September 1986.
- [7] Y. C. Jenq, "Approximations For Packetized Voice Traffic in Statistical Multiplexer", In Proc. IEEE INFOCOM, pp. 256–259, April 1984.
- [8] W. Jiang, H. Schulzrinne, "Analysis of On-Off Patterns in VoIP and Their Effect on Voice Traffic Aggregation", In Proc. of the 9th IEEE International Conference on Computer Communication Networks, Las Vegas, 2000.
- [9] M. J. Karam, F. A. Tobagi, "Analysis of the Delay and Jitter of Voice Traffic Over the Internet", In Proc. IEEE INFOCOM, Vol. 2, pp. 824–833, April 2001.
- [10] P. C. Mehta, S. Udani, "Overview of Voice over IP", Technical Report MS-CIS-01-31, University of Pennsylvania, February 2001.
- [11] H. Schulzrinne, "Voice Communication Across The Internet: A Network Voice Terminal", Technical Report TR 92-50, Dept. of Computer Science, University of Massachusetts, Amherst, Massachusetts, July 1992.
- [12] J. Seger, "Modelling Approach for VoIP Traffic Aggregations for Transferring Tele-traffic Trunks in a QoS enabled IP-Backbone Environment", International Workshop on Inter-domain Performance and Simulation, Salzburg, Austria, February 2003.
- [13] A. Y. Seydim, "Voice Over IP (VoIP)", Lecture notes, Digital Telephony Course, Southern Methodist University, December 1999.
- [14] K. Sriram, W. Whitt, "Characterizing Superposition Arrival Processes in Packet Multiplexers for Voice and Data", *IEEE Journal on Selected Areas in Communications*, SAC-4(6):833–846, September 1986.
- [15] T. E. Stern, "A Queueing Analysis of Packet Voice", In Proc. IEEE Global Telecomm. Conf., San Diego, USA, pp. 251–256, December 1983.
- [16] W. Whitt, "The Queueing Network Analyzer", *Bell Syst. Technical Journal*, Part 1, Vol. 62, no.9, pp. 2779–2815, November 1983.
- [17] ITU-T Recommendations, Telecommunication Standardization Sector of ITU.
- [18] A. Papoulis, S. U. Pillai, *Probabilities, Random Variables and Stochastic Process*, McGraw-Hill, New York 2002.
- [19] Wafo toolbox for Matlab, Wave Analysis for Fatigue and Oceanography, <http://www.maths.lth.se/matstat/wafo>
- [20] M. S. Taqqu, W. Willinger, R. Sherman "Proof of a Fundamental Result in Self-Similar Traffic Modeling", *Computer Communication Review*, Vol. 27, pp. 5–23, 1997.
- [21] A. Veres, Zs. Kenesi, S. Molnár, G. Vattay, "On the Propagation of Long-Range Dependence in the Internet", *ACM SIGCOMM 2000*, Stockholm, Sweden, August 28 - September 1, 2000.
- [22] W. Willinger, M. S. Taqqu, and A. Erramilli, *A bibliographical guide to self-similar traffic and performance modeling for modern high-speed networks*, Stochastic Networks: Theory and Applications (Oxford) (F. P. Kelly, S. Zachary, and I. Ziedins, eds.), Royal Statistical Society Lecture Notes Series, Vol. 4, pp. 339–366, Oxford University Press, 1996.