

A Low-cost and Low-weight Attitude Estimation System for an Autonomous Helicopter

Albert-Jan Baerveldt and Robert Klang

Center for Computer Systems Architecture,

Halmstad University,

Box 823

S-301 18 Halmstad, Sweden

Abstract –In this paper a low-cost and low-weight attitude estimation system for an autonomous helicopter is presented. The system is based on an inclinometer and a rate gyro. The data coming from the sensors is fused through a complementary filter. In this way the slow dynamics of the inclinometer can be effectively compensated. Tests have shown that we obtained a very effective attitude estimation system.

I. INTRODUCTION

Small autonomous helicopters would be very suited for inspections and surveillance tasks. Examples are inspections of power lines and buildings, looking for fires in forests, as well as military applications. Especially the capability of the helicopter to be able to hover is very useful. Model helicopters are in wide use all over the world mostly for hobby. Such a model helicopter is a good platform to start building an autonomous helicopter, as they can be bought at low-cost. In order to make the helicopter autonomously we need a computer-based system to control the attitude, i.e. the roll, pitch and yaw angles of the helicopter. On top of the attitude control system, a position controller is needed to control the position. Model helicopters have a pay-load of about 1 kg and are small in size with a rotor diameter of about 1.6 m. This means that the sensors and the on-board computer must be small in size and low-weight. Low-cost of the whole system is also required to be able to produce a cost-effective machine. Currently we are developing such an autonomous helicopter based on a commercially available model helicopter [1], [2].

In this paper we present a low-cost and low-weight Attitude Estimation System, AES, with high-bandwidth.

The AES is based on three rate gyro's, a two-axis inclinometer and a compass. The inclinometer has a too low bandwidth to be able to control the attitude of the helicopter. The rate gyro's measuring the rate of rotation offer however a sufficient bandwidth. The rate signal of the gyro can be integrated over time to obtain an angle measurement. The integrated signal of the rate gyro can be fused with the signal of the inclinometer to obtain the final attitude estimation. In this way the slow-dynamics of the inclinometer can be compensated with the integrated rate signal. We can not rely only on the integrated rate signal as we employ low-cost and low-weight gyro's with significant drifts of the signal. To fuse the signal we designed a complementary filter. After having identified the dynamics of all the sensors we tried several complementary filters and selected the best one. Tests have shown that we obtained a very effective attitude estimation system.

II. SENSORS

A Inclinometer

An inclinometer measures the tilt angle with respect to the field of gravity. We selected an electrolytic type of inclinometer as it has a relatively low weight and size compared with the mechanical pendulum type. The chosen inclinometer, a dual axis inclinometer model 900 of the company Applied Geomechanics, weights only 16 gram and costs about 400 dollar. The repeatability of the sensor is 0.02 degree. The signal processing unit incorporated in the sensor makes the sensor behave like a first order low pass filter with time constant $\tau=0.53$ s., which has been determined with a system identification procedure. The dynamic behavior is demonstrated in fig 1, where the true angle is plotted, measured with a potentiometer, against the output of the inclinometer. It is clearly shown that the considerable phase losses makes the

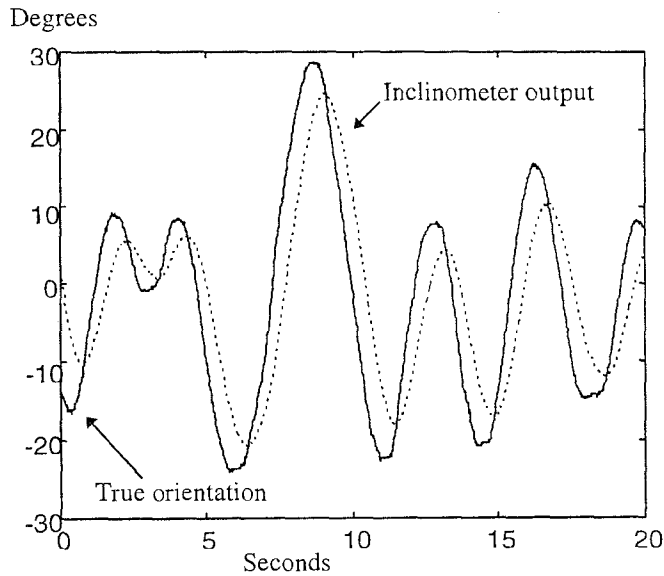

Fig. 1 Inclinometer performance. The solid line is the true orientation and the dashed line is the inclinometer output.

sensor alone unsuitable for the estimate of the attitude of the helicopter.

B Rate gyro

A rate gyro measures the rate of rotation. The angle of orientation can be obtained through integration of the sensor signal. We used a piezoelectric vibrating gyroscope: the ENV-05 Gyrostar from Murata. The Gyrostar is small, lightweight and inexpensive. It weighs 42 grams and costs about 300 dollar. The output noise is less than 0.5 degree/sec rms. As we have to integrate the signal even the smallest constant offset error grows to infinity. This property is known as drift. The drift rate of the Gyrostar, as quoted by the manufacturer is very poor: 9 degree/s. However, this is valid for the complete operating temperature range of the sensor which lies between -20 and 70 degree celsius. Other researchers which have employed and tested the sensor report drift rates under typical room temperatures of 0.05 to 0.25 degree/sec, which equates to 3 to 15 degree/min (see [3] and [4]). We made about the same experiences as can be seen in fig. 2 where the integrated signal of rate gyro is plotted against the true orientation, measured with a potentiometer. Here we can note a drift of about 25 degree/min. This rather high drift is due to the fact that the rate gyro was just switched on and not reached a stable temperature yet.

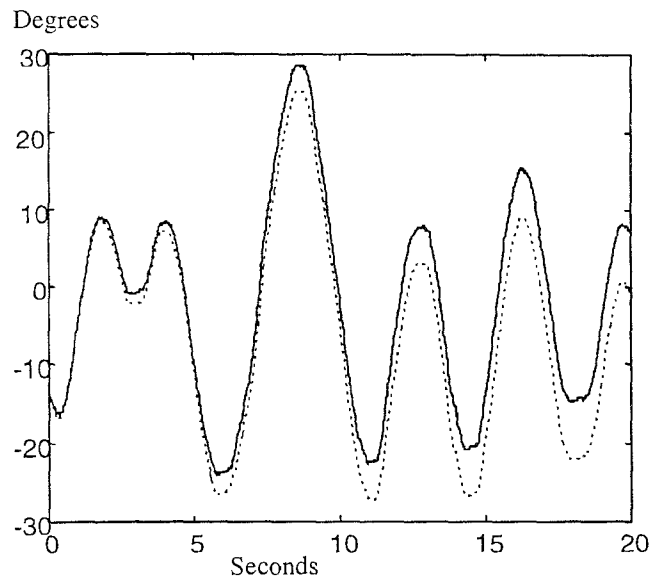

Fig. 2 Rate gyro performance. The solid line is the true orientation and the dashed line is integrated output of the rate gyro.

III. DESIGN OF THE COMPLEMENTARY FILTERS

The basic idea of the complementary filter is to combine the outputs of the inclinometer and rate gyro to obtain a good estimate of the orientation, thus compensating for the drift of the rate gyro and for the slow dynamics of the inclinometer.

The estimate of the angle of orientation is obtained as the sum of the signals from two measurements branches as illustrated in Fig.3. The inclinometer feeds its output signal into the filter $G_i(s)$ which provides the contribution of the inclinometer branch to the estimate in the low frequency domain. The rate gyro provides a value for the rotational velocity of the system which is fed into the filter $G_g(s)$. This filter is designed so that its output contributes to the estimate in the high frequency domain. The basic requirements for the filters can be formulated as follows (see also [5]).

1. The overall system should exhibit constant amplification and small phase loss up to frequencies well above the cut-off frequency of the inclinometer.
2. In order to keep the sensitivity to offsets of the rate gyro to a minimum, the inclinometer should be used in the widest possible ranges of frequencies.

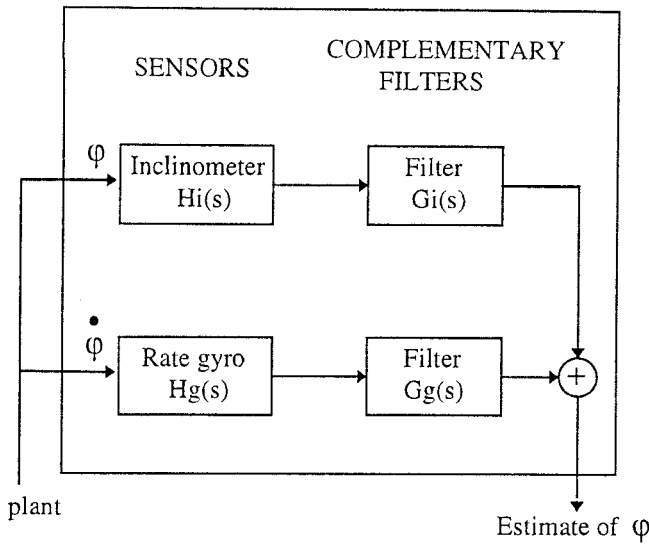

Fig. 3: Overview of the attitude estimation system using complementary filters. The sum of the output of the two branches yields the estimate of the orientation.

3. The number of design parameters should be small in order to ease the tuning and implementation of the filters.

In order for the estimate to exhibit the same dynamics as the actual angle of orientation, the filter transfer functions $G_i(s)$ and $G_g(s)$ must be chosen according to:

$$H_i(s) G_i(s) + s H_g(s) G_g(s) = 1, \quad \forall s \quad (1)$$

where $H_i(s)$ and $H_g(s)$ denote the transfer functions of the inclinometer and the gyro, respectively, while neglecting all nonlinearities. Two choices can be made now. One approach is to assume ideal sensors, i.e.:

$$H_i(s) = H_g(s) = 1 \quad (2)$$

The other approach is to take the known dynamics of the inclinometer into account, i.e. (see previous section)

$$H_i(s) = \frac{1}{0.53s + 1} \quad \text{and} \quad H_g(s) = 1 \quad (3)$$

A Design of the filters assuming ideal sensors

If we assume ideal sensors we obtain the following criterion for the filters $G_i(s)$ and $G_g(s)$ by combing eq. 1 and 2.

$$G_i(s) + s G_g(s) = 1, \quad \forall s \quad (4)$$

In order to keep the number of filter design parameters small we have chosen a second order filter with a double pole

$$G_i(s) = \frac{2\tau s + 1}{(\tau s + 1)^2} \quad (5)$$

$$G_g(s) = \frac{\tau^2 s}{(\tau s + 1)^2} \quad (6)$$

The filter $G_i(s)$ eq. (5), filtering the signal coming from the inclinometer is a first order low-pass filter (-20 db per decade) in series with a lead filter, whereas the branch of the gyro is a second order high pass filter with respect to the orientation φ (-40 db per decade). Please note that the term $2\tau s$ in the numerator in (5) could be moved to the numerator in (6), thus appearing as 2τ . This results also in useful filters, i.e. a second order low-pass for the inclinometer branch (becoming -40 db per decade instead of -20 db) and a first order high-pass for the gyro branch (becoming -20 db per decade instead of -40 db). As we want to minimize the influence of offsets of the rate gyro, we prefer the filters as described in (5) and (6), i.e. a second order high pass filter applied to the integrated signal of the rate gyro.

Now we have the filter time constant τ as the only filter design parameter. The time constant should be chosen as low as possible in order to minimize the influence of offsets of the rate gyro. However, as we assumed to have ideal sensors the time constant should be chosen well above the time constant of the inclinometer (0.53 sec) otherwise the inclinometer can not be regarded as an ideal sensor.

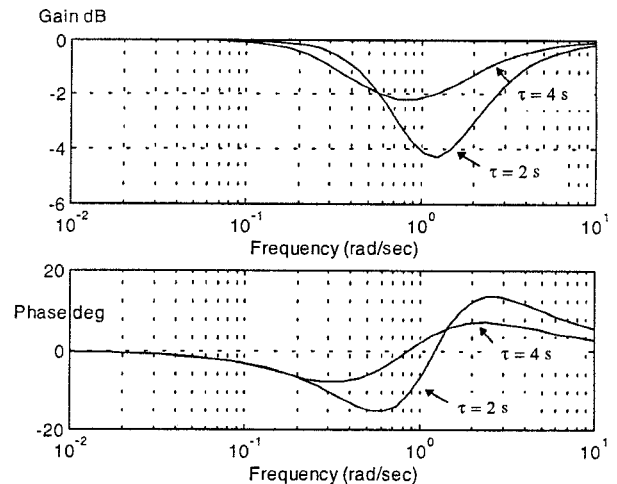

Fig. 4 Bode plot of the estimation system for two values of the time filter constant τ assuming ideal sensors.

Fig. 4 shows the frequency response of the estimation system for two values of the filter time constant, $\tau=2$ s. and $\tau=4$, with the inclinometer modeled as first order low pass filter with time constant 0.53 s. and the gyro as ideal sensor as in eq (3). It can be clearly seen that if we want to regard the inclinometer as ideal sensor we need to chose the time constant $\tau=4$ s or higher otherwise we obtain a too high signal distortion.

We tested the complementary filter with $\tau=4$ s and found that the offset error of the rate gyro was not effectively filtered. Therefore we investigated the design of a complementary filter which includes the inclinometer dynamics.

B Design of the filters including the inclinometer dynamics

If the known dynamics of the inclinometer is taken into account, we obtain the following criterion for the filters $G_i(s)$ and $G_g(s)$ by combing eq. 1 and 3.

$$\frac{1}{(0.53 s + 1)} G_i(s) + s G_g(s) = 1, \quad \forall s \quad (7)$$

Again by choosing a second order filter and by minimizing the influence of the offset of the gyro, we obtain the following filters.

$$G_i(s) = \frac{1.06 s + 1}{(0.53 s + 1)} \quad (8)$$

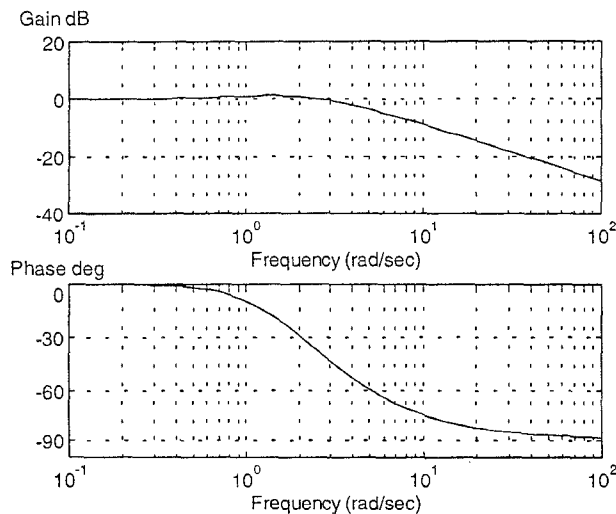

Fig. 5 Bodeplot of the contribution of the inclinometer branch to the estimate of ϕ ($H_i(s) G_i(s)$ eq.3 and 8)

$$G_g(s) = \frac{0.28 s}{(0.53 s + 1)^2} \quad (9)$$

The filter time constant is no longer a design parameter but is equal to the time constant of the inclinometer. The results can be easily verified by setting $\tau = 0.53$ in (5) and (6) and calculating the new filter $G_i(s)$ by dividing $G_i(s)$ as in (5) by $H_i(s)$.

In fig. 5 the bodeplot is shown of the inclinometer branch of the complementary filter, which is obtained by the dynamics of the inclinometer in series with the filter $G_i(s)$ as in equation 8. This filter is a lead filter which thus improves the phase losses of the inclinometer. The maximum gain at a frequency of about 1.5 rad/sec is about 1.15 db (which equals 14.5 % magnification).

In fig. 6 the bodeplot is shown of the rate gyro branch of the complementary filter, which is a second order high pass filter. The gain of -50 db at a frequency of 0.1 rad/sec proved to be sufficient to cancel the offset error of the rate gyro sensor.

By comparing the bodeplot of both branches it can be seen that especially in the frequency range between 1 and 10 rad/sec both sensors together contribute significantly to the filter output (minimum gain of -10db, i.e. at least 33 %). In this frequency range, which equals 0.15 to 1.5 Hz. we also expect the rotational movements of the helicopter to be. At higher frequencies the rate gyro dominates more and more the filter output whereas at lower frequencies the inclinometer dominates.

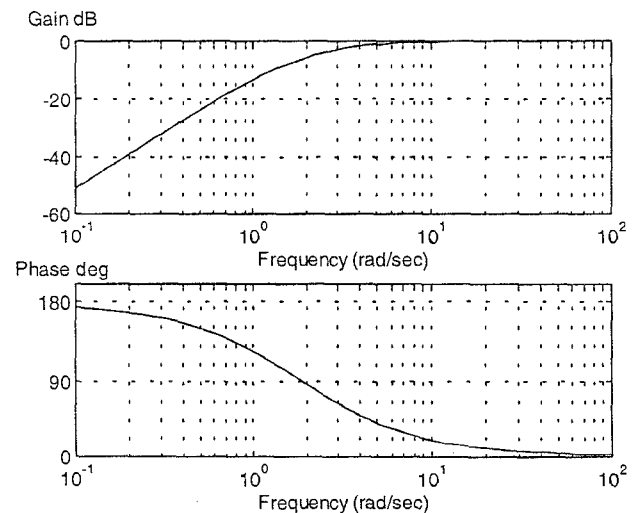

Fig. 6 Bodeplot of the contribution of the gyro branch to the estimate of ϕ . ($s G_g(s)$, $G_g(s)$ as in eq 9)

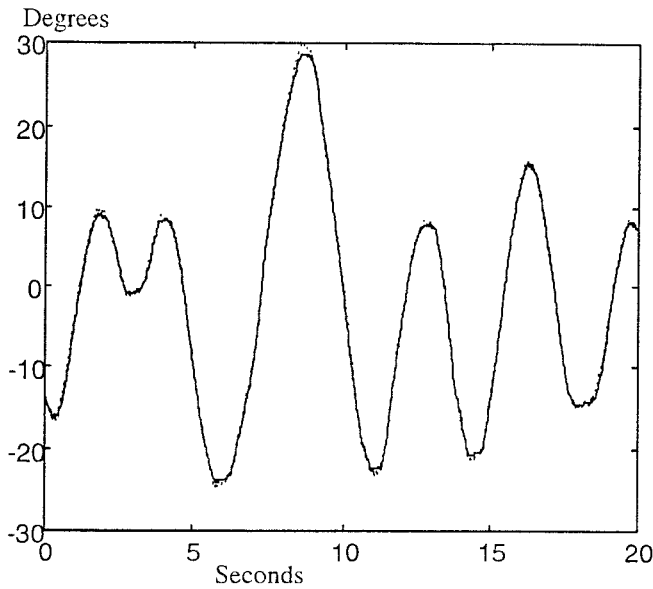

Fig. 7 Complementary filter performance. The solid line is the true orientation and the dashed line is the output of the complementary filter.

IV. RESULTS AND CONCLUSIONS

We tested the attitude estimation systems with various signals, while recording the true orientation with a potentiometer. The filter proved to effectively cancel the offset error of the rate gyro. In fig. 7 the estimate of the complementary filter is shown together with the true orientation. The signal contains frequencies in the aforementioned range of 0.15 and 1.5 Hz where both sensors contribute significantly to the filter output. The complementary filter proved to give a good estimate of the orientation. The almost neglectable differences which are visible at the peaks of the signal are probably due to calibration errors of the potentiometer and/or the inclinometer and can thus be removed by better calibration.

In fig. 8 the contribution of both sensor branches are shown together with the filter output which is formed by the sum of the two signals.

It can be concluded that a low-cost and low-weight attitude estimation system has been obtained based on complementary filtering. The next step in our project is to use the attitude estimation system to control the attitude of our model helicopter.

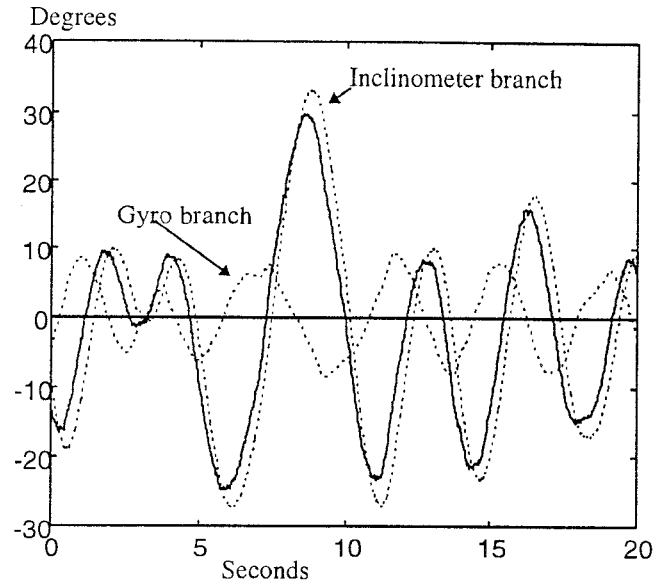

Fig. 8 Contribution of the two sensor branches to the filter output. The solid line is the filter output and the dash lines are the contribution of the branches.

V. REFERENCES

- [1] H.F. Gustafsson and K.J. Westberg, "Towards an Autonomous Helicopter". Master Thesis, Technical Report CCA - 9511, Halmstad University, Sweden, June 1995.
- [2] R. Klang and M. Persson, "Autonomous Flying Helicopter: Attitude Control". Master Thesis, Technical Report CCA - 9706, Halmstad University, Sweden, January 1997.
- [3] B. Barshan and H.F. Durrant-Whyte, "Inertial Navigation Systems for Mobile Robots", IEEE Transactions on Robotics and Automation, Vol. 11, No. 3, June 1995.
- [4] J. Borenstein and L. Feng, "Gyrodometry: A New Method for Combining Data from Gyros and Odometry in Mobile Robots", Proc. of the Int. Conf. on Robotics and Automation, Minneapolis, April 1996.
- [5] M. Zimmermann and W. Sulzer, "High Bandwidth Orientation Measurement and Control Based on Complementary Filtering", Proceedings of SYROCO '91, IFAC Symposium on Robot Control, Vienna, Austria, September 1991.