

COGNITIVE RADIO APPLICATIONS IN SOFTWARE DEFINED RADIO

John Polson (john.polson@gdds.com)

GENERAL DYNAMICS C4 Systems
8220 East Roosevelt Street MD R5220
Scottsdale, Arizona 85257, USA

ABSTRACT

The topic of cognitive radios has been garnering a great deal of attention in the past several years. Opinions regarding the level of sophistication necessary to qualify a system as cognitive vary widely, and discussions have ensued regarding this technology. The software defined radio forum is also involved and has working group activity in the area of cognitive radio. Some of the working group results are shown in this paper.

The modern software defined radio is the heart of a cognitive radio. The applications executing on the radio distinguish a cognitive radio from a software-defined radio. Additional hardware in the form of sensors and actuators enables more cognitive radio applications. Some of the enabling technology is presented in this paper. Various artificial intelligence approaches to machine learning and decision making may be applied to the cognitive radio system.

In this paper, a survey of related cognitive radio topics is reviewed and candidate application architectures are presented. Section 1 is an introduction to the basis of cognitive radios from a hardware, software, and artificial intelligence point of view. Section 2 discusses the sensors and actuators needed by a cognitive radio. Section 3 presents software architectures for radio learning and ultimately cognition. Section 4 is the heart of the paper and describes three candidate cognitive radio applications. Some future trends and conclusions are presented in Section 5.

1. COGNITIVE RADIO ENABLING TECHNOLOGY

Software Defined Radio (SDR) and Artificial Intelligence (AI) technology enable the new field of Cognitive Radio (CR). An overview of these two areas is presented in this section.

Cognitive Radio

A Cognitive Radio is an extension of modern Software Defined Radio. This extension creates new capabilities for users. The evolution of radio technology is shown in Figure 1. An “aware radio” has sensors and is aware of the environment (or at least a subset of the environment). An “adaptive radio” is aware of its environment and is capable of changing its behavior in response. The next level is CR, and the following characteristics are included in my concept of a CR:

- Sensors creating awareness in the environment
- Actuators enabling interaction with the environment
- Memory and a model of the environment
- Learns and models specific beneficial adaptations
- Has specific performance goals

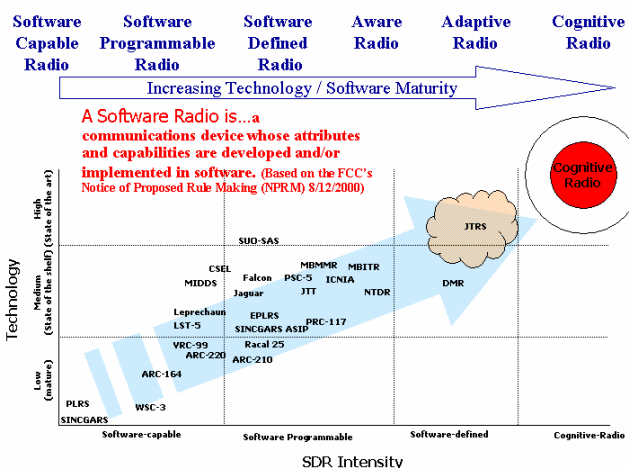

Figure 1 – Cognitive Radio. The next goal in the development of SDR technology is a Cognitive Radio because CR enables new capabilities.

The regulator’s desire of absolutely predictable behavior is beyond the scope of this paper. Questions such as the following must be addressed: Is all learning accomplished prior to fielding the system? Is learning and

behavior constrained? How is this demonstrated to regulators?

The SDRF Cognitive Radio Working Group is developing a different set of definitions along these lines. The nomenclature document will be released soon and the Cognitive Radio discussed in this paper is similar in concept to the Heuristic Radio in the SDRF Cognitive Radio Working Group documents.

Software Defined Radio

A software-defined radio has several major sub-systems, but is essentially a distributed computing system. In this section, the major sub-systems are discussed.

RF Front End

A SDR requires a general purpose RF front end. This typically requires a wide tuning range, ideally it tunes from DC to light notwithstanding the technical problems. A pre-selector / power amplifier allows the selection of a subset of the spectrum, and either tunable filters or fixed filters are used for this purpose. A Rx or Tx chain processes the radio signal in the analog domain. These chains may be combined into a single, bi-directional path at design time. Finally, a synthesizer is required to generate the local oscillators for processing (Figure 2). The analog processing is software configurable through the setting of switches to select filters and through the setting of registers to control mixer frequencies.

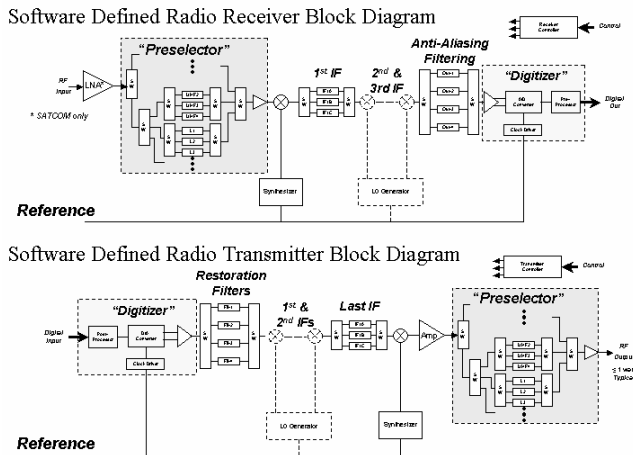
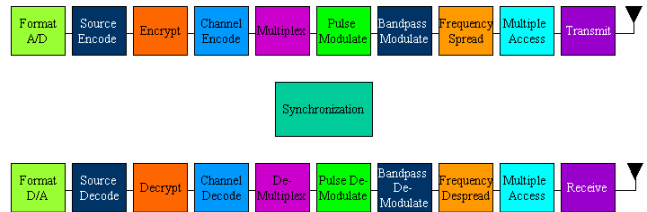

Figure 2 – General SDR RF Frontend. The RF Frontend has the following sections: Pre-selector / Power Amplifier, Receive Chain, Transmit Chain, and Synthesizer [1].

MODEM

The MODEM subsystem accomplishes the modulation and demodulation of the data stream using digital methods. A general MODEM architecture is shown in Figure 3 [2].

In high performance MODEMs FPGA processing resources are usually needed to accommodate high sample rates. FPGAs are programmed in hardware definition languages such as VHDL or Verilog. For more SW portability or for floating point signal processing, DSP resources are programmed in assembly or high level programming languages.



FPGA Processing Resources

- High Sample Rate
- Highly Parallel Computations
- HDL Specifications for Images
- Fixed Point Arithmetic (Primarily)

DSP Processing Resources

- Lower Sample Rates
- Sequential Computations
- Code Defined Processing
- Fixed or Floating Point Arithmetic (Depends on Parts Selection)

Figure 3 – MODEM Architecture. High performance MODEMs usually require FPGA resources and often include DSP optimized microprocessors for enhanced SW portability.

General Purpose Processing Capabilities

FPGA and DSP processing resources are not optimized for protocol applications or for AI applications. High performance SDRs typically have General Purpose Processing resources that are programmed in high-level languages.

Cryptographic Capabilities

Military radios usually require Cryptographic security functions. For High Assurance systems, this involves dedicated hardware. There are commercially available, software programmable cryptographic processors for these requirements.

Software Architecture

One of the most critical architectural features in a SDR is the software structure or software architecture. Usually a standard Real Time Operating System with a standard interface such as POSIX is considered advantageous. Figure 4 shows a solid software architecture for a SDR. Cognitive Radio Applications execute in the top layers where waveforms execute.

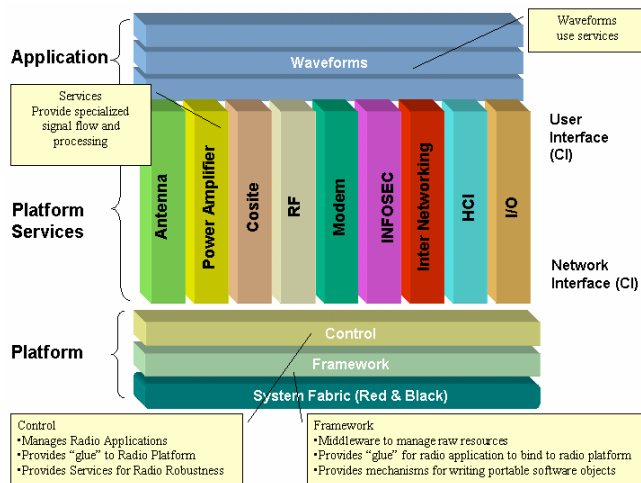

Figure 4 – SDR Software Architecture. A layered SW architecture supports SW portability and enables CR applications to be added easily.

Artificial Intelligence Technology

The heart of a Cognitive Radio application is in its ability to improve performance through learning. Artificial Intelligence techniques enable such changed behavior.

An agent is an entity that perceives and acts, and an agent model correct for a Cognitive Radio application. There is a continuum of sophistication in agent architecture. Figure 5 shows four smart agent architectures [3].

The first agent architecture has no memory and is a simple mapping of percepts to actions. This would be an aware application. The second architecture has state memory and may achieve more sophisticated behavior and could be considered an adaptive application. The third architecture has a model of the environment and can estimate the results of alternatives; this is the minimum level of sophistication for a CR application. The final architecture shown, also has a model for the environment, but may make judgmental decisions based on a utility function.

There are a variety of artificial intelligence techniques available to realize the models in an agent. Standard searching solutions (Figure 6) are well understood, but they must be coupled with a state model.

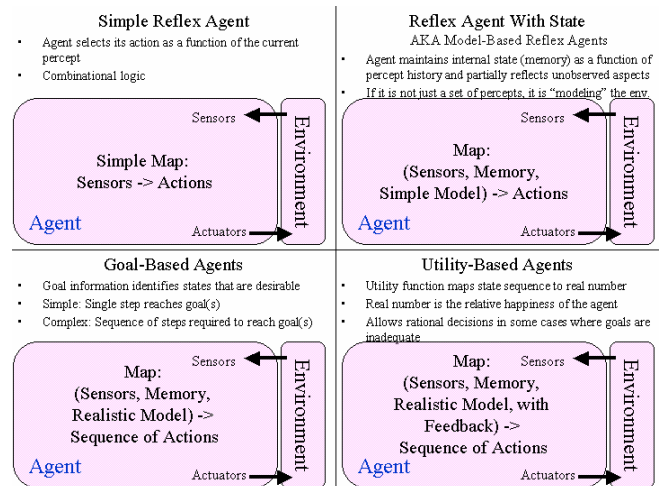

Figure 5 – Four Smart Agent Architectures. Agents may be very simple or sophisticated; an agent is the proper AI architecture for many CR applications.

Genetic algorithms may be used to explore the action space in a controlled manner. In a well-understood environment, a knowledge-based system can make excellent decisions. Neural engineering techniques may be used to explore the possible relationships between percepts and good actions [3]. In the next section, potential sensors and actuators for Cognitive Radio applications are discussed.

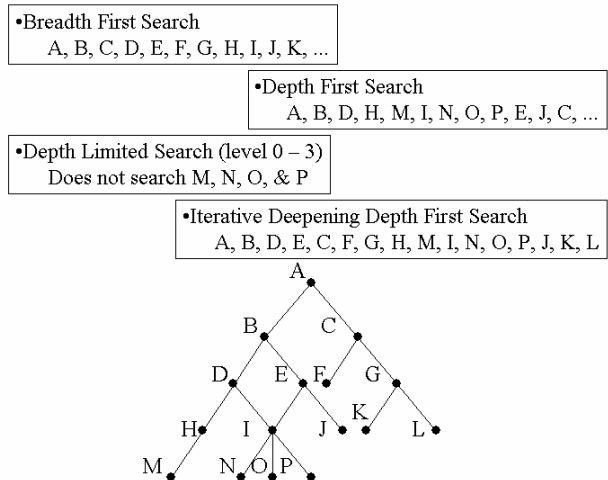

Figure 6 – Search Algorithms. Various state search algorithms yield different performance, time or space complexity, as a function of environment.

2. SENSORS AND ACTUATORS FOR COGNITIVE RADIOS

The sensors and actuators in a cognitive system are of particular interest. If a cognitive system has a RF transmitter and a RF receiver, it is a Cognitive Radio. Additional

sensors and actuators are possible and their introduction enables different applications. For example, a Radio that has a fingerprint reader in the push-to-talk switch can learn who should or should not use the system. It can also be used to enable access list controls. The following two sections suggest some sensors and actuators for Cognitive Radio applications.

Sensors

RF receiver using either single or multiple omni or directional antennas is required for a Cognitive System to be a Cognitive Radio. A voice radio has a microphone that could readily be used as an acoustic sensor. One possible use is for voice print authentication. A camera is currently being integrated into cellular telephones and could be included in a CR for the purpose of authentication.

A SDR usually has a Human Machine Interface (HMI). This is a sensor of the environment and enables the user to input directions for the CR application. If there is a requirement for authentication or user identification, a biometric sensor may be employed.

Geolocation significantly enables cognitive applications, and some of these applications are discussed in Section 4. A GPS receiver may be used to establish location. An inertial navigation system input could be used for geolocation or planning applications. Sophisticated waveforms can also establish relative position.

Modern cell phones are currently being fitted with chemical sensors. The point of these sensors is to detect bad breath or blood alcohol levels [4]. Military Cognitive Radios may soon be fitted with sensors to detect NBC materials and automatic notification of danger and planning applications may help to extricate the user from some threat.

Actuators

A CR requires a transmitter and may utilize the same types of antennas described above. The CR may adjust all the transmission characteristics from frequency to power level.

Voice radios have a speaker that allows acoustic interaction with the environment. The CR may notify its user through a variety of aural outputs. A CR will have an HMI that allows the radio to interact with its user. The current state of the radio and suggestions for action on the part of the user can be displayed.

3. LEARNING ARCHITECTURES

Learning systems require observations to draw conclusions [3]. For example, a neural network is initially trained by providing a set of known inputs and desired outputs, and it is these observations that are used by the neural network to learn the desired behaviors. Feedback, provided by the desired outputs in the example, is required for learning.

When a sequence of observations and feedback is used, the process is called inductive learning. When multiple predictions, extracted from an environmental model, are combined, the process is called ensemble learning.

An inductive learning system that includes background knowledge has potential for better performance when compared to a pure inductive learning system because it starts in a better situation. Any fielded CR will have an initial set of knowledge.

Statistical models of learning include Bayesian computations of probability as a function of the percepts. Self organizing maps, such as Kohonen networks or Backpropagation Neural Networks, are also considered statistical learning due to the training trials.

The reinforcement of actions from feedback is essential for reinforcement learning. Genetic Algorithms generate new candidate control words through a randomizing mechanism that crosses successful control words with each other. A feedback mechanism determines when the candidate rules are allowed to survive or if they are removed from the system.

A human expert constructs a knowledge system. Behaviors must be designed into the knowledge system, but well characterized and understood behaviors are produced.

4. CANDIDATE COGNITIVE RADIO APPLICATIONS

In this section, three classes of cognitive applications for CR are discussed. These three classes are Spectrum Sensing and Spectrum Access Applications, Geolocation and Networking Applications, and finally, Authentication Applications.

Spectrum Sensing and Access Applications

Spectrum access is primarily limited by regulatory constraints, and recent measurements show that spectrum occupancy is low when examined as a function of frequency, time, and space [5]. Cognitive Radios may sense the local spectrum utilization either through a dedicated sensor or using a configured SDR receiver channel. Using this information it may create increased spectrum access opportunities.

One of the primary considerations for such a cognitive application is non-interference with other spectral uses. Figure 7 shows a measurement of local spectrum utilization. If the regulatory body is allowing cognitive radios to utilize the unoccupied "white space," increased spectral access can be achieved. The CR can examine the signals and may extract detailed information regarding the use. By estimating the other uses and monitoring for interference, two CR may rendezvous at an unoccupied "channel" and communicate.

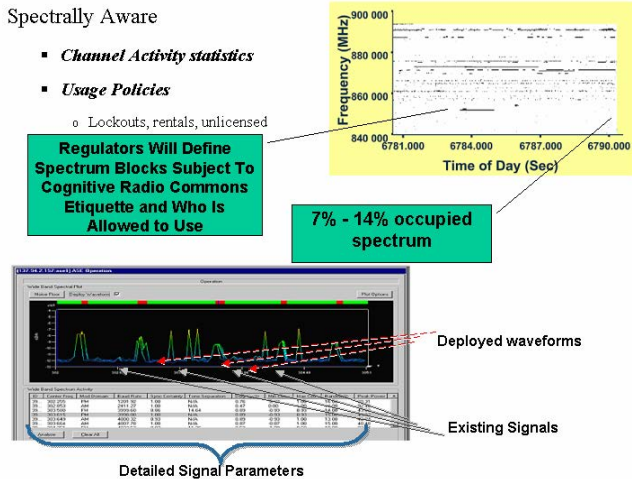

Figure 7 – Spectrum Awareness. A CR or a set of CRs may be aware of the spectrum and may exploit unoccupied spectrum for their own purposes.

Sophisticated waveforms that have “look through” capability are called for in this application. Dynamic selection of channels to utilize or vacate is important. Simulations of these cooperating CR already exist, and field demonstrations are expected in 2005. Another advantageous waveform characteristic is discontinuous spectrum occupancy. This allows communication around other existing signals. Careful analysis is needed to ensure sufficient guard bands are utilized.

Since spectrum utilization is a spatially and temporally variant phenomenon, repeated monitoring is required and cooperative, distributed coordination is needed. The familiar hidden node and exposed node problems have to be considered.

Geolocation and Networking Applications

New capabilities are enabled when a CR knows where it is and where it is going. This information may be obtained through dedicated sensors such as an Inertial Navigation Unit, a GPS receiver, or through relative geolocation techniques built into the waveforms or configuration of an SDR channel to receive and process GPS signals.

An inertial navigation unit keeps track of location relative to an initial known location through the use of accelerometers and time. The accuracy of this technique deteriorates in time, but re-synchronization with GPS receivers mitigates this characteristic. Through a combination of Inertial Navigation and GPS, a CR can sense its location with good precision, even indoors.

If a precise relative location is required, various techniques may be used. One technique uses RAKE receiver parameters from multiple spatially distributed

receivers and time difference of arrival (TDOA) equations to find range and position of target transmitters.

Figure 8 shows various applications enabled by sensing its own position. This enables CR to have spatially variant policies or to locate locally available network services or access points.

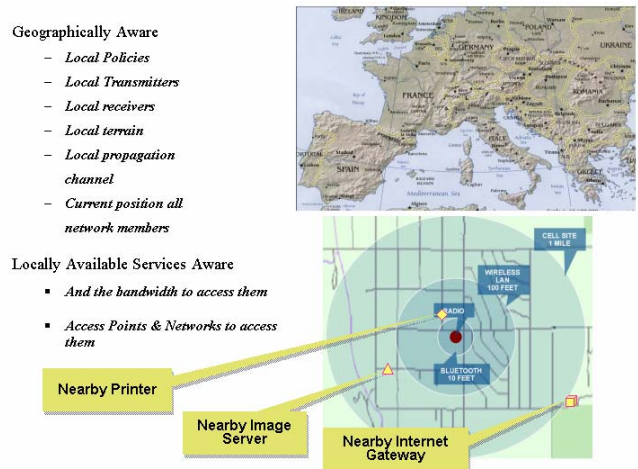

Figure 8 - Geolocation. A CR that has knowledge of its position may apply appropriate spatially variant policies such as frequency lockouts or may access networking capabilities that are available in that vicinity.

A mobile network of CRs may learn to improve energy utilization. As an example, less energy is required to transmit over several short hops as compared to a few long hops and a set of CRs could learn to cooperatively conserve their batteries. Another example where CRs may apply location information is in routing protocols; CRs may learn to match the right routing protocol, proactive or reactive, to the situation.

Some cell phone service providers allow subscribers to get reports on the location of their handset. A CR can learn when its owner wishes to receive a report via e-mail, pager, or phone call. As an example, a parent may provide his teenager a CR handset. Over time, the CR learns the teenager’s schedule. When the teenager has changed his schedule, the CR can report. This has direct military application in the form of blue force tracking.

Authentication Applications

A Cognitive Radio can learn the identity of its user(s). Authentication applications can prevent unauthorized users from using the CR.

Since a radio is usually used for voice communications, there is a microphone in the system. The captured signal is encoded with a VoCoder and transmitted. The source radio can authenticate the user and add the

known identity to the data stream. At the destination end, decoded voice can be analyzed for the purposes of authentication.

Recently cell phones have been equipped with digital cameras. This sensor coupled with facial recognition software may be used to authenticate a user.

Other biometric sensors may be used for authentication and access control. Figure 9 shows some of the potential sensors and their relative strengths and weakness in terms of reliability and acceptability [6].

Biometrics In Order of Effectiveness	Biometrics In Order of Social Acceptability
1. Palm Scan	1. Iris Scan *
2. Hand Geometry	2. Keyboard Dynamics
3. Iris Scan	3. Signature Dynamics
4. Retina Scan	4. Voice Print **
5. Finger Print	5. Facial Scan *
6. Voice Print	6. Finger Print ***
7. Facial Scan	7. Palm Scan ***
8. Signature Dynamics	8. Hand Geometry ***
9. Keyboard Dynamics	9. Retina Scan *



A Cognitive Radio may authenticate a user through a variety of biometric measures. Traditional handsets (left) may be modified to capture the necessary inputs for redundant biometric authentication.

* Requires a camera sensor
 ** Utilizes a copy of the voice input (low impact)
 *** Requires a Sensor in the PTT Hardware

Figure 9 – Biometric Authentication. A CR with appropriate sensors may authenticate its users.

5. FUTURE TRENDS FOR COGNITIVE RADIO

Planning applications are one of the new attractive technologies that CR will enable. Navigation using databases and GPS signals will increase. The CR can remember prior paths and can learn better routes. Figure 10 shows a generalized approach to planning from an AI point of view. This structure will enable this new class of application for Cognitive Radios.

Planning => a sequence of actions enabling a problem solver to accomplish a specific task

- Robotics Applications
- Expert Systems *
- Natural Language Understanding *

* Natural extension for Cognitive Radio Applications

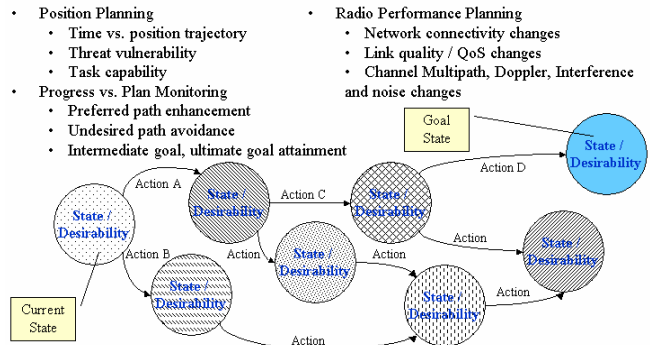

Figure 10 – Planning Applications. CRs will evolve to the point where they can plan

Some of the planning applications envisioned are:

- Route planning
- Battery Management
- Noise Discipline
- Light Discipline
- Management of Information Flow
- Role Assignment as a function of the operator’s skills
- Talk Group Assignment
- Smart Calibration
- Smart Bridge (recognize the need for two or more legacy to communicate and connect them through a bridge)

CR applications are on the horizon due the enabling technologies of AI and SDR. The co-integration of these two fields of study will create new capabilities for the commercial and military marketplaces.

6. REFERENCES

- [1] Sharrit, Paul. Internal Overview Briefing. General Dynamics 2004
- [2] Sklar, Bernard. Digital Communications Fundamentals and Applications Second Edition. Prentice Hall 2001.
- [3] Russell, Stuart J. and Peter Norvig Artificial Intelligence A Modern Approach Second Edition. Pearson Education 2003.
- [4] Reuters September 22, 2004.
- [5] Federal Communications Commission. “Spectrum Policy Task Force Report”. *ET Docket No. 02-135* November, 2002.
- [6] Harris, Shon. CISSP All-in-One Exam Guide, Second Edition. McGraw Hill, 2002.