

LTE NETWORK ARCHITECTURE EVOLUTION

Ville Eerola
Helsinki University of Technology
ville.eerola@tkk.fi

Abstract

The aim of this paper is to give an overview of current mobile network architecture and the step by step approach to the Long Term Evolution (LTE). Also this paper tries to present the advantages why operators are willing to invest to new technology.

The path to LTE will include many improvements to network elements in existing mobile networks. This paper will concentrate also to describe the main functions of the most important network elements.

Key Words

Long term evolution, LTE, UMTS, HSPA, Flat Architecture

1. Introduction

Nokia Siemens Networks (Nokia Siemens Networks) and UMTS forum (UMTS Forum, 2009) argues that data traffic in existing WCDMA/HSPA and CDMA networks is growing dramatically year by year. This causes a need for mobile operators to update their existing networks to match growing data needs. Building up a network infrastructure is very expensive and complicated work. Operators demand continuation and backward compatibility from the new innovations which are brought to the networks. This is one of the main factors that current mobile networks are extremely complex and varies between different operators. Journey to LTE will include steps where amount of network elements is reduced to simplify the network architecture. These are first steps towards flat architecture. Even with these improvements the LTE network will be complex because symbiotic relationships exist between the various elements within the system. (Nokia Siemens Networks)

Operators are looking for wider bandwidth, efficiency and lower costs from their networks. From the picture 1 it is easy to see that there is a high pressure to move from circuit switched networks to packet switched networks to lower the cost per bit. LTE is an important evolutionary step that builds on GSM/EDGE and WCDMA/HSPA to make higher data rates for mobile broadband services economically viable. Also LTE allows the possibility to use wide range of bandwidths. (Nokia Siemens Networks)

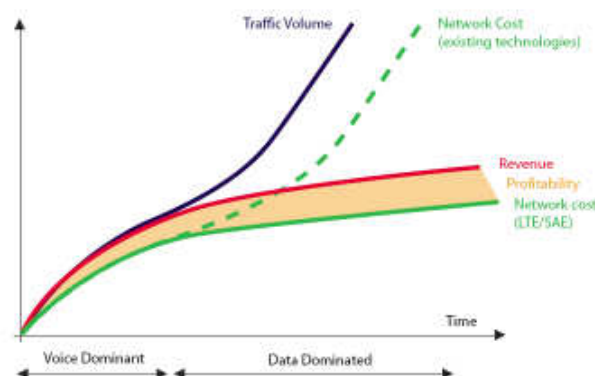

Picture 1: The cost per bit must be reduced for operators to remain profitable (UMTS Forum, 2009)

2. Background of LTE

During 2004 3rd Generation Partnership Project (3GPP) started to investigate requirements for UMTS Terrestrial Radio Access Network (UTRAN) LTE. Workshops were held with many telecommunications industry players. During these workshops it was agreed that feasibility study for new packet-only radio system will be started. During the feasibility study following key requirements was defined for the new system (Holma & Toskala, 2007) (UMTS Forum, 2008):

- Packet-switched domain optimization
- Roundtrip time between server and user equipment (UE) must be below 30ms and access delay below 300 ms
- Uplink peak rate 75 Mbps
- Downlink peak rate 300Mbps
- Improvements to mobility and security
- Terminal power efficiency improvements
- Wide frequency flexibility with 1.25/2.5, 5, 10, 15 and 20MHz allocations
- Capacity increase compared to 3GPP release 6 (HSDPA/HSUPA)

LTE technology has many benefits when compared to current 3G networks. UMTS Forum (UMTS Forum, 2008) describes that from a technical point of view, the main objective of the LTE project is to offer higher data rates for both down- and uplink transmission. Another main improvement for LTE is to reduce packet latency. By reducing latency responsiveness of gaming, VoIP, videoconferencing and other real-time services are improved greatly. Dr. Michael Schopp (Schopp) defines that the main benefit of LTE is that it can deliver services at fixed line quality with cost of IP

technologies. 3G Americas (3gamericas) argues that main benefit of LTE is the simplified and flat all IP architecture which helps to reduce both latency and cost of the network. Dahlman et al (Dahlman, ym.) defines that the benefits of LTE comes from increased data rates, improved spectrum efficiency, improved coverage, and reduced latency.

Table 1: Uplink and downlink data rates compared for HSPA and LTE (UMTS Forum, 2008)

	HSDPA	HSDPA / HSUPA	HSPA +	LTE (20 MHz)
Uplink	384 kbit/s	5,76 Mbit/s	11,5 Mbit/s	75 Mbit/s
Downlink	14,4 Mbit/s	14,4 Mbit/s	28 Mbit/s	300 Mbit/s

Based on all of these we can say that the LTE will bring benefits for many areas compared to current telecommunications networks. However the biggest competitive affect from the network operator point of view will be its reduced cost per bit.

Market for UMTS/HSPA is estimated to grow until 2013 but it is good to remember that LTE networks are not in that far in the future. Some LTE networks are already ramped-up e.g. DoCoMo in Japan has a prototype LTE network (Fierce Broadband Wireless, 2009). Picture 2 presents a basic timeframe for different network improvements.

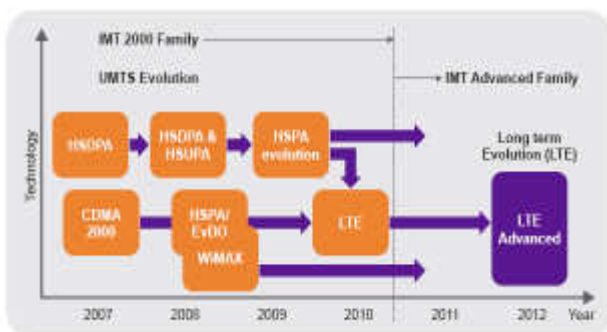

Picture 2: Evolution timeframe for network systems (Nokia Siemens Networks)

3. LTE technology

To reach the higher data rates and faster connection times LTE contains a new radio interface and access network. During 3GPP organized workshops it was agreed that the technology solution chosen for the LTE air interface uses Orthogonal Frequency Division Multiplexing (OFDM). Also to reach the agreed data levels multiple input / multiple output (MIMO) technologies, together with high rate modulation were agreed. (UMTS Forum, 2009)

LTE uses the same principles as HSPA for scheduling of shared channel data and fast link adaptation. This enables the network to optimize cell performance dynamically. LTE does not contain dedicated channels carrying data to specific users because it is based entirely on shared and broadcast channels. This increases the efficiency of the air interface as the network no longer has to assign fixed levels of resource to each user but can allocate air interface resources according to real time demand. (UMTS Forum, 2009)

3.1 OFDMA

3GPP needed to make quite radical changes to LTE radio interface because enhancements to WCDMA technology could cause major problems with power consumption. Also the processing capability required in LTE would have made the resulting technology unsuitable for handheld mobile devices. OFDM-based technology was chosen because it can achieve the targeted high data rates with simpler implementations involving relatively low cost and power-efficient hardware. (UMTS Forum, 2009)

It is good to notice that OFDMA is used in the downlink of LTE but for the uplink Single Carrier – Frequency Division Multiple Access (SC-FDMA) technology is used. SC-FDMA is technically similar to OFDMA but it suits better for handheld devices because it is less demanding on battery power. (3GPP, 2008) (UMTS Forum, 2009)

5 MHz channel width causes constrains in data rates of WCDMA networks. To overcome these limitations in LTE networks bandwidths up to 20 MHz are deployed. If wider RF band such as 20 MHz would be used in WCDMA it could cause a group of delay problems which limits the achievable data rates in WCDMA. LTE removes these limitations by deploying OFDM technology to split the 20 MHz channel into many narrow sub-channels. Total data throughput is generated by combining these sub-channels together. (UMTS Forum, 2009)

In Orthogonal Frequency Division Multiple Access (OFDMA) system different sub-channels are assigned to different users. Thousands of these narrow sub-channels are deployed to send many messages simultaneously. Then those are combined at the receiver to make up one high speed message. (UMTS Forum, 2009)

3.2 MIMO

Today's mobile networks are very noisy environments. Noise in the mobile networks is created by other users, neighboring cell sites and thermal background noise. Without noise, an infinite amount of information could be transmitted over a finite amount of spectrum. Shannon's Law formulated by mathematician Claude

Shannon, states that there is a fundamental limit to the amount of information that can be transmitted over a communications link. The volume of error-free data that can be transmitted over a channel of any given bandwidth is limited by noise (UMTS Forum, 2009).

To minimize the effects of noise and to increase the spectrum utilization and link reliability LTE uses MIMO technique to send the data. The basic idea of MIMO is to use multiple antennas at receiver end and use multiple transmitters when sending the data. Before sending the data transmitter converts serial bit streams output by the source into multiple parallel sub streams. Then transmitter sends them via different transmit antennas using the same time slot and the same frequency band. After receiving data receiver separates out the original sub streams from the mixed signals using the non-correlation of signals on multiple receive antennas caused by multipath in the transmission. This leads to significant increases in achievable data rates and throughput. Shannon's Law applies to a single radio link between a transmitter and a receiver. By using MIMO technique Shannon's law can be bended a little bit. In MIMO each individual radio link is limited by Shannon's Law but collectively they can exceed it. (UMTS Forum, 2009) (Liu)

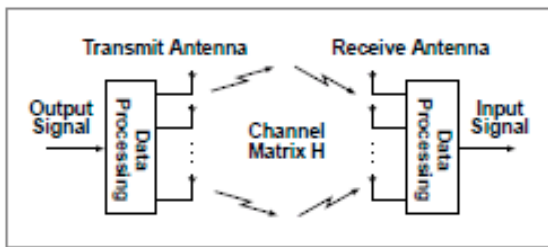

Picture 3: MIMO system diagram (Liu)

3.3 High rate modulation

Third important technological improvement agreed by 3GPP to reach the needed data rates is related to modulation of the data. In data modulation transport wave and transmitted data are combined together. There are many different techniques to do the modulation. In LTE modulation techniques are extreme complicated. Table 2 defines the different modulation techniques which are used in LTE. (3GPP, 2008)

Table 2: LTE modulation techniques (3GPP, 2008)

	Downlink	Uplink
QPSK	x	
16QAM	x	x
64QAM	x	
BPSK (pii/2-shift)		x
QPSK		x
8PSK		x

4. LTE impact on network architecture

Trend in the telecommunications industry has been moving away from circuit switched networks towards packet data services. GPRS brought the first data services to the GSM networks. UMTS with HSPA continued the same trend with much higher data speeds.

LTE provides a smooth evolutionary path for operators deploying all 3GPP and non-3GPP technologies. This causes that there are not one specific path to LTE. Every upgrade case will be different depending on existing technology and network architecture. This chapter tells one possible evolution path from 2G/3G network to LTE. (UMTS Forum, 2008)

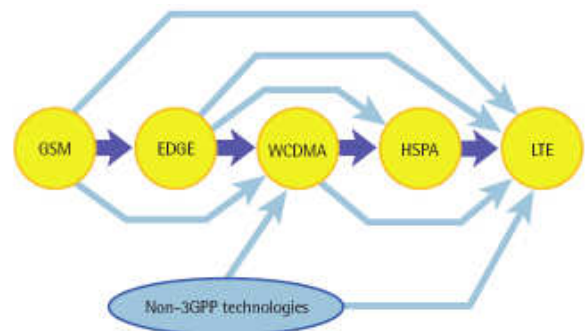

Picture 4: Different LTE evolutionary paths (UMTS Forum, 2008)

4.1 GSM and WCDMA network

Today's mobile networks are rarely ramped up from scratch. Most of the networks have evolved through time and that makes the variation of networks vast. Picture 5 presents a network which is evolved from GSM network to UMTS network. The network has two parts; Radio access network (RAN) and core network (CN). Core network is usually divided to packet core network (PS) and circuit switched network (CS). Radio access network handles all radio related functionalities and the core networks is responsible of switching and routing calls and data connections to external networks. (Holma & Toskala, 2007)

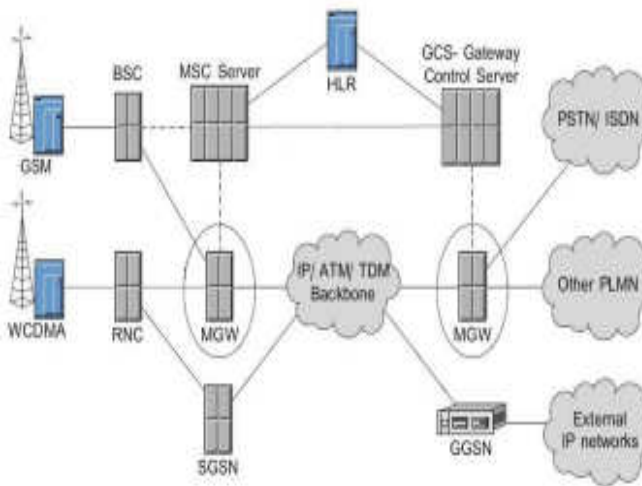

Picture 5: 2G and 3G Network (Nokia, 2006)

In a GSM network base (transceiver) stations (BTS) and base station controllers (BSC) are the functional units of the radio access network. WCDMA radio access network includes same kinds of elements than GSM RAN. UMTS base stations are called node Bs and base station controllers are called Radio Network Controllers (RNC). (Holma & Toskala, 2007)

The base station and node B are used to facilitate wireless communication between user equipment (UE) and a network. Node B takes also part in radio resource management.

The base station controller (BSC) and radio network controller (RNC) are the brains behind the base stations. Normally a base station controller or a radio network controller has tens or even hundreds of base stations under its control. The BSC and RNC have many different responsibilities and functions, couple of those are the handling of radio resources and controlling of handovers between BSC to BSC or RNC to RNC. (Holma & Toskala, 2007)

Main network elements in the circuit switched core network are mobile services switching center/visitor location register (MSC/VLR), home location register (HLR), media gateway (MGW). These network elements provide circuit switched connections like PSTN and ISDN. (Holma & Toskala, 2007)

Serving GPRS support node (SGSN) and gateway GPRS support node (GGSN) network elements provide the packet data services in the networks. (Holma & Toskala, 2007)

Home location register (HLR) is a database located in the subscriber's home system. HLR stores the master copy of user's service profile. Information about the subscriber and all allowed services, forbidden roaming areas and supplementary service information like call forwarding status are stored to service profile. The service profile is created when a new user joins to the system for example by purchasing a new Elisa SIM card. (Holma & Toskala, 2007)

Mobile services switching center/visitor location register (MSC/VLR) is the brains in the core networks. It is the switch (MSC) and database (VLR) which serves the user equipment (UE) in its current location for circuit switched services like speech. Visitor location register holds a copy of visiting user's service profile and the location of the user equipment inside of the serving system. (Holma & Toskala, 2007)

Media gateway (MGW) is a network element which resides at the boundary between radio access network and core networks. The MGW can be used for transmitting and converting the user plane traffic in both circuit-switched core networks and IP multimedia core network as a border element between different kinds of networks. The MGW provides a number of configurations for different purposes depending on the network environment in which the MGW is located and on the needed interface types. (Dahlin & Örnulf, 1999)

Serving GPRS support node (SGSN) functionality is very similar to the functionality of MSC/VLR but SGSN is used for packet switched services. Serving GPRS support node (SGSN) main responsibilities are the delivery of data packets from and to the user equipments (UE) within its geographical service area. Its other tasks include packet routing and transfer, mobility management, logical link management and authentication and charging functions. Location information and user profiles are stored in the location register of the SGSN. All GPRS users registered with this SGSN. (Holma & Toskala, 2007)

The gateway GPRS support node (GGSN) is another main component of the packet network. The GGSN main responsibility is to handle the interworking between the GPRS network and external packet switched networks, like the Internet. (Holma & Toskala, 2007)

4.2 HSPA (3GPP R6)

First step towards LTE is High Speed Packet Access (HSPA) improvements to existing UMTS release 99 networks. Improvements are needed because telecommunications industry is moving from circuit switched technology towards packet switched technology. High Speed Packet Downlink Access (HSDPA) and Enhanced Uplink (EUL) (High Speed Uplink Packet Access (HSUPA)) are the main improvements in 3GPP release 6 to extend and improve the performance of existing UMTS networks. (Mobile broadband today)

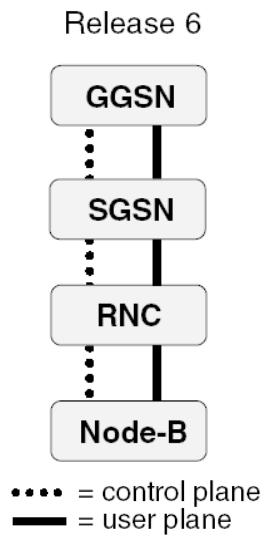

Picture 6: HSPA release 6 (Holma & Toskala, 2007)

High Speed Packet Downlink Access (HSDPA) improves theoretical down-link performance of up to 14 Mbit/s. High Speed Uplink Packet Access (HSUPA) improves up-link performance theoretically up to 5.8 Mbit/s. (3GPP, 2008)

High Speed Packet Downlink Access (HSDPA) and High Speed Uplink Packet Access (HSUPA) improvements to existing UMTS release 99 networks are done by improving the software run in the node Bs and radio network controllers (RNC). So there is no need to change existing node B or RNC hardware during the upgrade. (Mobile broadband today)

4.3 Evolved HSPA (HSPA+) (3GPP R7)

In release 7 new improvements were brought to HSPA by 3GPP. Main improvements were multiple input/multiple output (MIMO) antenna capability and 16QAM (Uplink) / 64QAM (Downlink) modulation. With help of these improvements HSPA+ Uplink speed is increased to 11Mbps and downlink speed to 42Mbps. (3GPP, 2008)

From network architecture point of view Direct tunneling and I-HSPA brings up the biggest changes to previous releases. When the direct tunneling and flat radio architecture (I-HSPA) solutions are combined, there are only two network elements in the user plane. This is the same way than in LTE architecture. (Holma & Toskala, 2007)

4.3.1 Direct tunneling

Holma and Toskala describe in their book (Holma & Toskala, 2007) that when using so-called direct tunnel solution user plane will bypass SGSN. This will increase the flexibility in network topology and allows

the SGSN node to be optimized for control plane. This is the first step towards system architecture evolution (SAE) which is the base for LTE. (Fritze, 2008)

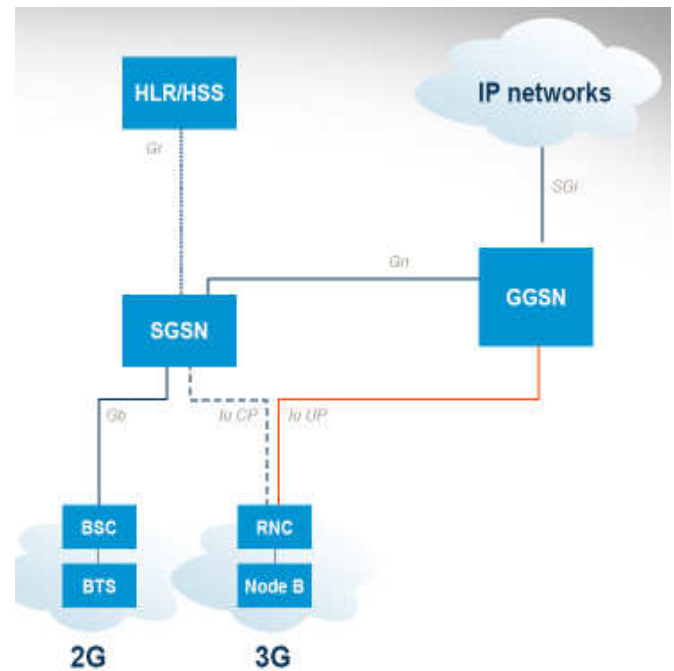

Picture 7: HSPA direct tunneling (Fritze, 2008)

HSPA Direct Tunneling is designed especially to be used when upgrading legacy GGSN/UTRAN networks. (Fritze, 2008)

4.3.2 Internet-HSPA (I-HSPA)

Internet-HSPA introduces flat architecture solution without the presence of separate RNC in network. RNC functionalities are integrated to the Node B. (Holma & Toskala, 2007)

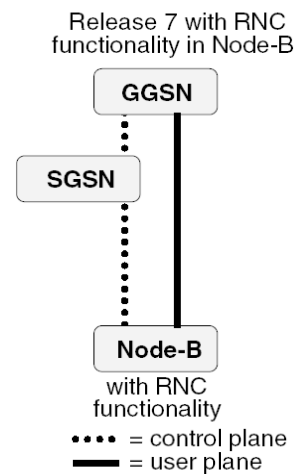

Picture 8: I-HSPA (Holma & Toskala, 2007)

I-HSPA is designed for heavy data users over the wireless network. Data in I-HSPA bypasses the radio

network controller (RNC) and the SGSN, and offloads data directly to the Internet via GGSN. This reduces the capacity bottlenecks in critical network elements like RNC and SGSN. (telephonyonline.com, 2005)

4.4 LTE (3GPP R8)

The 3GPP evolution for the 3G mobile system defined the UTRAN Long Term Evolution (LTE) and System Architecture Evolution (SAE) network. These standards define an all-IP network as a base for the LTE/SAE. The LTE/SAE does not have separate packet switched data traffic and circuit switched voice network. Both data and user plane communicates over the same network, which is called Evolved Packet System (EPS) network. (Fritze, 2008)

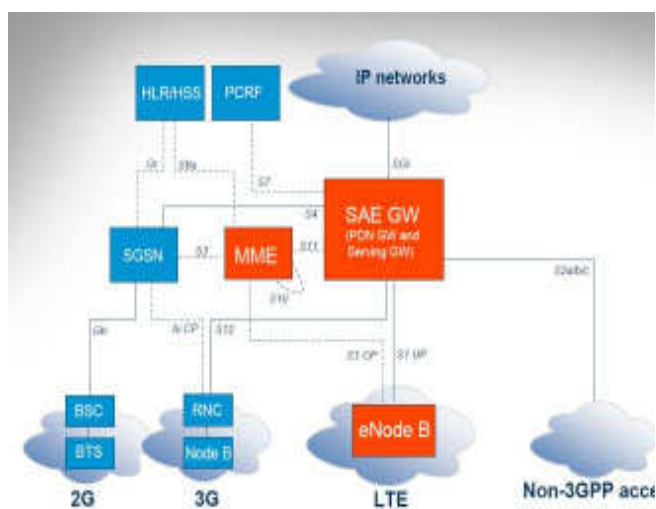

Picture 9: LTE/SAE architecture (Fritze, 2008)

LTE/SAE network includes many new network elements like MME and SAE GW. Only remaining element in radio access network is (enhanced) eNode B. (Holma & Toskala, 2007)

eNode B is the base station in the LTE/SAE network. Its main functions are (Fritze, 2008)

- Radio resource management
- IP header compression and encrypting of user data stream
- Selection of an MME at UE attachment
- Routing of user plane data towards SAE gateway
- Measurement and measurement reporting configuration for mobility and scheduling

Some of the existing Node Bs (e.g. Nokia Siemens Networks Flexi-BTS) can be upgraded to eNode B by just a SW installation. (Nokia Siemens Networks, 2009)

SAE gateway consists two different gateways; Serving SAE gateway and Public Data Network (PDN) SAE

gateway. Serving SAE gateway is the contact point to the actual network when Public Data Network (PDN) SAE is the counterpart for external networks. These gateways are used to process the user-plane data. These gateways also handle the tasks related to the mobility management inside LTE and between other 3GPP radio technologies. SAE gateway is a SW upgrade to existing GGSN network element. (Fritze, 2008) (Holma & Toskala, 2007)

Mobility management Entity (MME) main task is to take care signaling of control plane, and especially for mobility management and idle-mode handling. SAE GW is upgraded from SGSN by installing new Software. (Fritze, 2008) (Holma & Toskala, 2007)

Home Subscriber Server (HSS) can be compared to Home Location Register (HLR) in UMTS network. It contains the subscription-related information (subscriber profiles), performs authentication and authorization of the user, and can provide information about the subscriber's location and IP information. (Holma & Toskala, 2007)

Policy and Charging Rules Function (PCRF) is used to manage quality of service and applied charging policies. (Holma & Toskala, 2007)

In LTE the voice calls are delivered over the Internet or other IP networks in a totally packet-based session. This solution is better known as Voice over IP (VoIP). VoIP has some advantages compared to circuit switched voice. These advantages are a richer user experience through its integration with other packet services. These possibilities include HD voice (wideband voice), packet based video telephony, video sharing, low-latency gaming, place shifting of media and social networking. (UMTS Forum, 2009)

LTE network combined with GSM and UMTS networks will be complex because the network will have so many symbiotic relationships between the various elements within the system. For example voice handover between LTE and UMTS networks is not possible to do. Facing these challenges will generate work for years to come. (Nokia Siemens Networks)

5. Conclusion

Data rates are growing rapidly in the mobile networks which are a very good sign for LTE. End users are starting to use the data services which are available for them. More and more new services are launched to boost the usage of data in the mobile networks. To fulfill the growing demand operators need to upgrade their networks to serve their customers better. LTE will bring 10 times higher data rates with 10 times lower latency than current HSPA networks can provide. From the operator point of view flat architecture of LTE provides significant savings on the CAPEX and OPEX. LTE equipments are using less electricity, need less

cooling and are smaller in size. These advantages bring huge savings for operators.

The LTE/SAE approach is also suitable for replacing existing CDMA2000 networks which provide e.g. Ericsson and Nokia Siemens Networks a great opportunity to penetrate new markets.

It is also good to remember that LTE technology is very complicated especially when the network include GSM and UMTS parts. This causes great challenges to telecommunications infrastructure companies to make the needed inventions and make the new technology as reliable as the existing one. Also fierce competition on the telecommunications industry and global regression could cause delays to the LTE launches.

Despite the great challenges that the new technology and global economics I would predict that during the next five years LTE networks will be deployed around the world.

6. Bibliography

- 3gamericas. (n.d.). *Q&A: LTE*. Retrieved 2 22, 2009, from <http://www.3gamericas.org/index.cfm?fuseaction=page&pageid=561>
- 3GPP. (2008). *HSPA*. Retrieved 3 2009, 1, from 3GPP: <http://www.3gpp.org/HSPA>
- 3GPP. (2008). *UTRA-UTRAN Long Term Evolution (LTE) and 3GPP System Architecture Evolution (SAE)*. Retrieved 2 25, 2009, from ftp://ftp.3gpp.org/Inbox/2008_web_files/LTA_Paper.pdf
- Dahlin, S., & Örnulf, E. (1999). *Network evolution the Ericsson way*. Retrieved 3 18, 2009, from Ericsson Review : http://www.ericsson.com/ericsson/corpinfo/publications/review/1999_04/88.shtml
- Dahlman, E., Ekström, H., Furuskär, A., Jading, Y., Karlsson, J., Lundevall, M., et al. (n.d.). *The 3G Long-Term Evolution – Radio Interface Concepts and Performance Evaluation*. Retrieved 2 22, 2009, from http://www.ericsson.com/technology/research_papers/wireless_access/doc/the_3g_long_term_evolution_radio_interface.pdf
- Fierce Broadband Wireless. (2009, March 17). *DoCoMo pushes 120 Mbps using LTE*. Retrieved 3 29, 2009, from <http://www.fiercebroadbandwireless.com/>: <http://www.fiercebroadbandwireless.com/story/docomo-pushes-120-mbps-using-lte/2009-03-17>
- Fritze, G. (2008, 4 10). *SAE The Core Network for LTE*. Retrieved 3 2, 2009, from http://www.nt.tuwien.ac.at/fileadmin/users/wkarner/2008-04-10_SAE.pdf
- Holma, H., & Toskala, A. (2007). *WCDMA for UMTS - HSPA evolution and LTE*. Wiley.
- Liu, M. (n.d.). *Analysis on Applying the MIMO Technique to WiMAX*. Retrieved 3 29, 2009, from ZTE Corporation: <http://www.zte.com.cn/main/include/showemagazine/article.jsp?articleId=12337&catalogId=12166>
- Mobile broadband today. (n.d.). *HSPA Technology*. Retrieved 2 25, 2009, from <http://hspa.gsmworld.com/hspa-technology/default.asp>
- Nokia. (2006, January 10). *Engineering for Multimedia Gateway (MGW). Nokia Multimedia Gateway (U3B) Product Documentation*. Nokia.
- Nokia Siemens Networks. (n.d.). *Long Term Evolution (LTE) will meet the promise of global mobile broadband*. Retrieved 3 19, 2009, from Long Term Evolution (LTE): http://www.nokiasiemensnetworks.com/NR/rdonlyres/52C8ACBF-8CC8-4177-9FA4-1F47137C2197/0/LTE_motivation_A4_0902.pdf
- Nokia Siemens Networks. (2009). *Long Term Evolution*. Retrieved 3 18, 2009, from http://www.nokiasiemensnetworks.com/global/Insight/network_efficiency/network_simplification/LTE+connected.htm?languagecode=en
- Nokia Siemens Networks. (n.d.). *LTE performance for initial deployments*. Retrieved 3 19, 2009, from Long Term Evolution (LTE): http://www.nokiasiemensnetworks.com/NR/rdonlyres/4B75329B-3750-4BBB-8320-7113613AAB64/0/LTE_measurement_A4_1302.pdf
- Schopp, D.-I. M. (n.d.). Retrieved 2 22, 2009, from <http://www.comnets.uni-bremen.de/typo3site/uploads/media/ITG-FA52-Schopp-Bremen-Nov-2006.pdf>
- telephonyonline.com. (2005, 3 15). *Move over HSDPA; Nokia's got a new acronym*. Retrieved from telephonyonline.com: http://telephonyonline.com/wireless/ctia2005/news/nokia_ahspa_umts_031505/
- UMTS Forum. (2009, February). *Mobile Broadband Evolution: the roadmap from HSPA to LTE*. Retrieved 3 29, 2009, from UMTS Forum: http://www.umts-forum.org/component/option,com_docman/Itemid,12/
- UMTS Forum. (2008, February). *Towards Global Mobile Broadband*. Retrieved 3 29, 2009, from UMTS Forum: http://www.umts-forum.org/component/option,com_docman/Itemid,12/